



Unit Model #: 5665 1 203

Mower: Spartan

Owner's Manual: Q0564

Mower Type: RT-Pro, RT-HD, SRT-XDe & SRT-XD (Check for Mower's w/ Oil Guard, will need A2325)

Deck Size: 72"

Vac Type: Pro 12

Deck Type:

Drive Type: PTO-X Driven

Revision #: 1 PTO-X 1.5 - 6/24/24 BS

Fits Year(s): 2018 & Newer

☐ A2316 Vac Kit

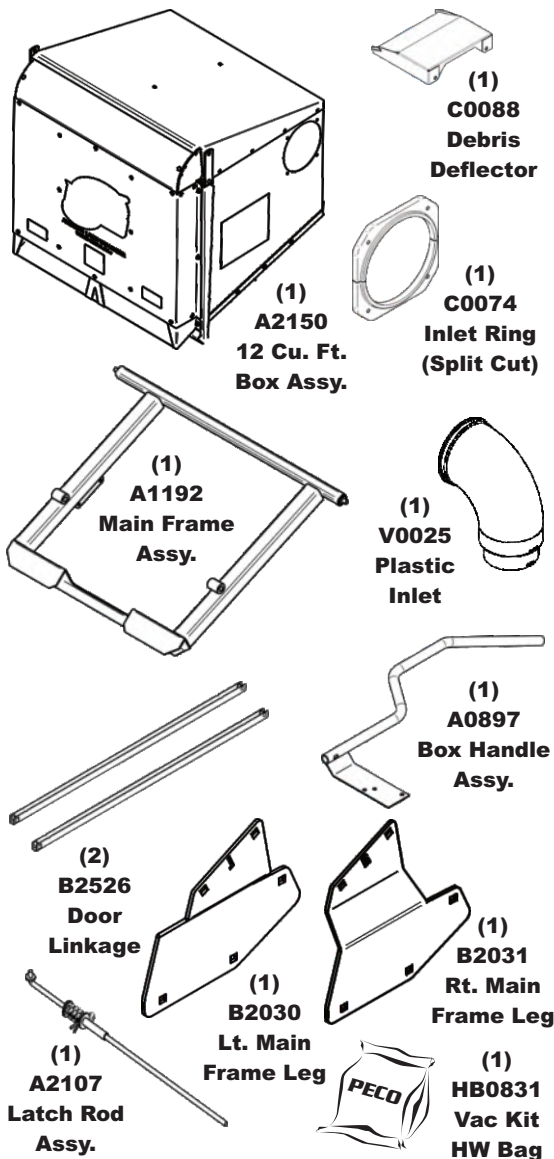

☐ A2323 Mount Kit

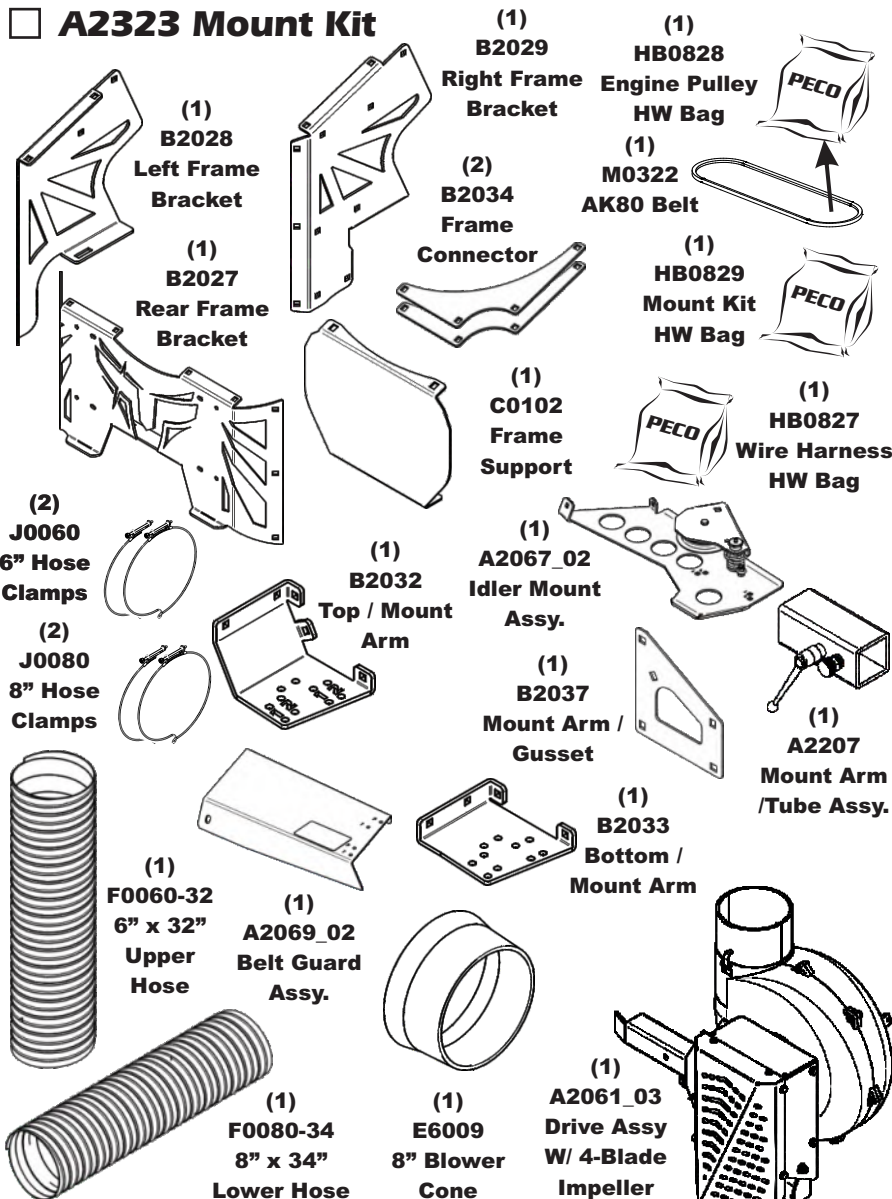

☐ A2315 Boot Kit

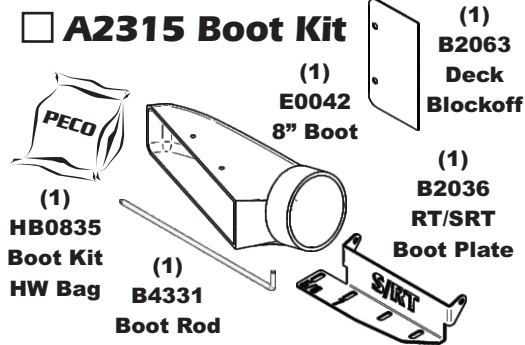

☐ A2162 Quad Weight Kit / Single Caster

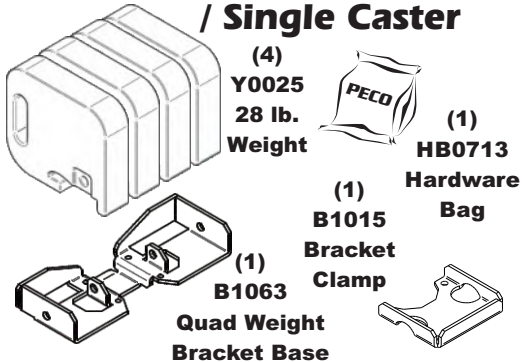

☐ A2121 Dual Weight Kit / Single Caster

