

# MODEL#: 35621228

**MOWER NAME: EXMARK**

**MOWER MODEL: LAZER Z NEXT GENERATION**

**MOWER DECK SIZE: 48" 52" 60" & 72"**

**VAC NAME: 12 CUBIC FOOT BOX**

**6.5HP BRIGGS AND STRATTON VANGUARD**

**MANUAL: Q0384**



**FOR YEAR: 2009 - 2023**

**REVISED: 01/17/2024**

## **A1704 - UNIT ASSEMBLY**

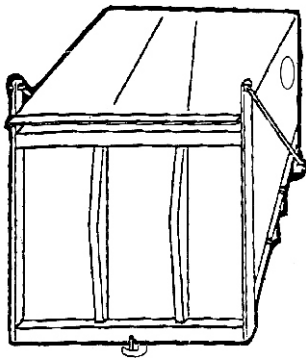

(1)  
**A0794**  
12 CU. FT. BOX  
ASSEMBLY



(1) **V0025**  
6" & 7"  
Inlet



(2)  
**J0060**  
6" HOSE  
CLAMPS



(2)  
**J0080**  
8" HOSE  
CLAMPS



(1)  
**HB0369**  
HARDWARE  
BAG

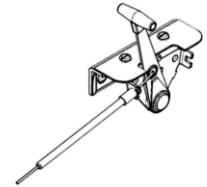

**A0060 - THROTTLE  
CABLE KIT (70")**

(1)  
**A0601**  
MAIN FRAME  
ASSEMBLY

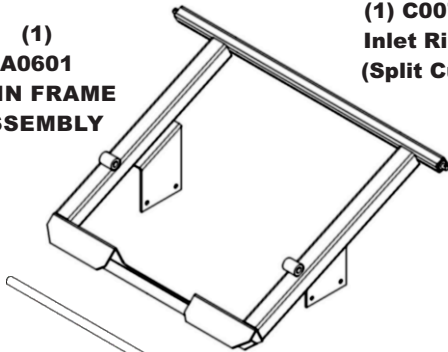

(1) **C0074**  
Inlet Ring  
(Split Cut)



(1)  
**A0600**  
OUTER ENGINE  
MOUNT TUBE  
ASSEMBLY



(1)  
6" x 31"  
UPPER  
HOSE



(1)  
8" x 42"  
LOWER  
HOSE



(1)  
**A0318**  
MOTOR MOUNT  
ARM ASSY.

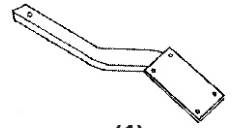

(1) **C0088**  
Debris  
Deflector

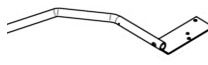

(1)  
**E6009**  
8" BLOWER  
CONE

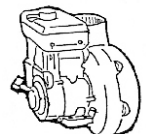

(1)  
**A639**  
ENGINE/BLOWER  
BLADE ASSY.

(1)  
**A0273**  
BOX HANDLE

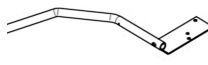

(1) **B0529 LEFT &  
B0528 RIGHT**  
LOWER MAIN  
FRAME LEGS

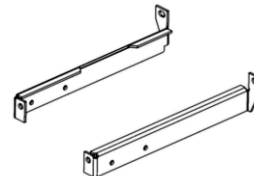

(1) **A0260**  
Latch Rod  
Assy.

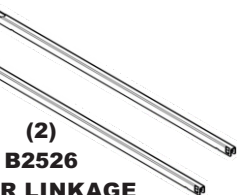

(2)  
**B2526**  
DOOR LINKAGE

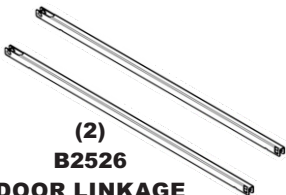

## **A0641 - BOOT KIT**

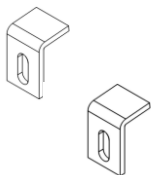

(2)  
**B0538**  
BOOT PLATE



(1)  
**HB0207**  
HARDWARE  
BAG

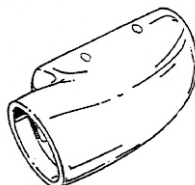

(1)  
**E1039**  
BOOT

## **A0665 - WEIGHT KIT**

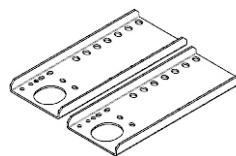

(2)  
**B0026**  
WEIGHT  
BRACKETS

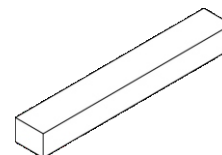

(1)  
**B2220**  
WEIGHT BAR



(1)  
**HB0370**  
HARDWARE  
BAG