

MODEL#: 41031303

MOWER NAME: FERRIS

MOWER MODEL: IS 3100Z

MOWER DECK SIZE: 61"

VAC NAME: 13 CUBIC FOOT PRO BAGGER

6.5 BRIGGS AND STRATTON VANGUARD

MANUAL: Q0407



FOR YEAR: 2010

REVISED: 12/20/11

A1783 UNIT ASSEMBLY

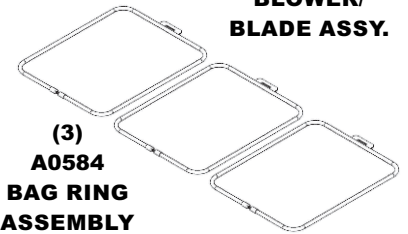
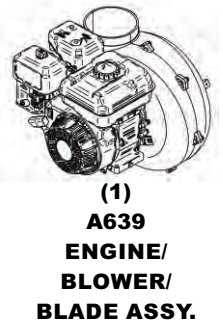
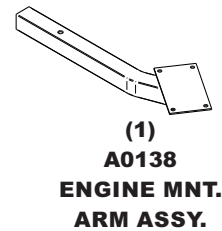
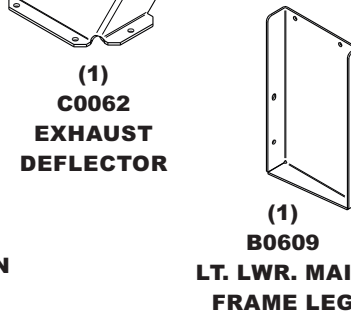
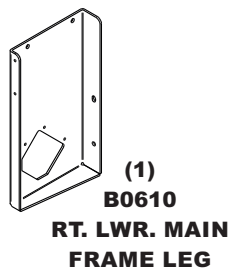
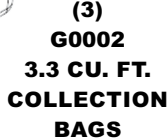
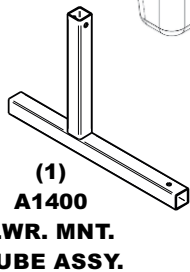
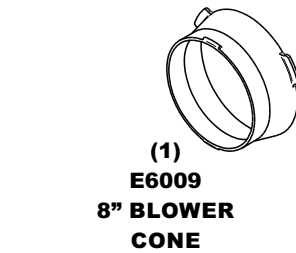
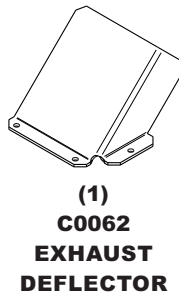
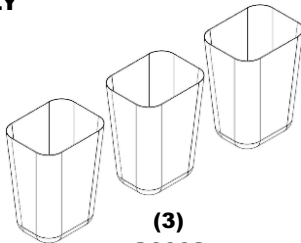
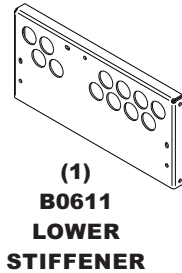
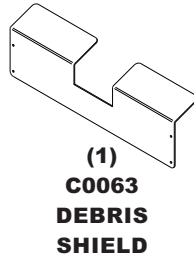
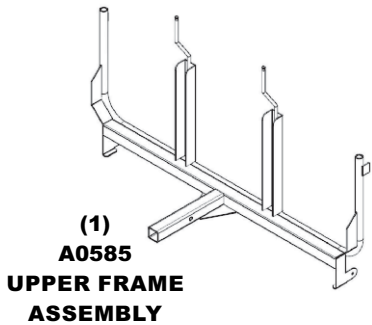
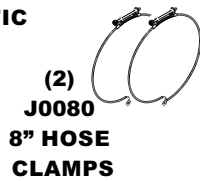
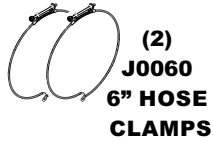
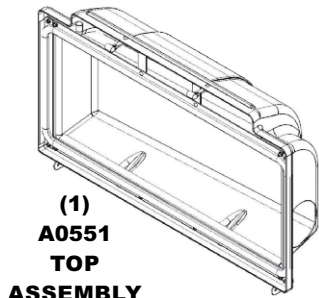

A1784 - WEIGHT KIT

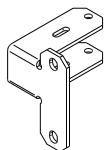

(2)
B0383
WEIGHT
BRACKET

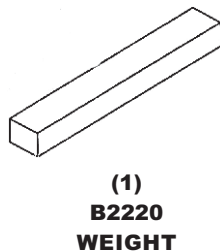

A1785 - BOOT KIT

