

MODEL#: 43621203

MOWER NAME: BUNTON

MOWER MODEL: BZT-2250

MOWER DECK SIZE: 52" & 61" DECK

VAC NAME: 12 CUBIC FOOT BOX



FOR YEAR: 2005 & BELOW

REVISED: 04/26/06

WAS:
436212-PTO-03

A0521 12 PTO UNIT ASSEMBLY

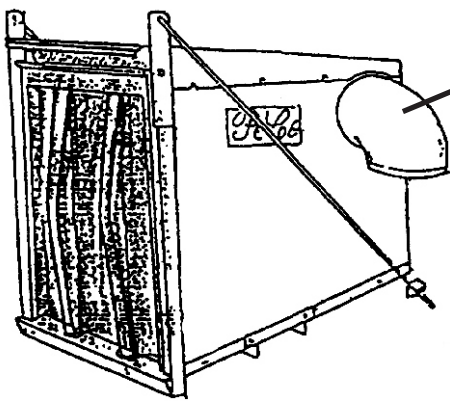

(1)
V1054
6" PLASTIC
INLET

(1)
A0794
12 CU. FT. BOX
ASSY.



(1)
6" x 35"
UPPER
HOSE



(1)
8" x 40"
LOWER
HOSE



(4)
J1000
2"-10" HOSE
CLAMPS

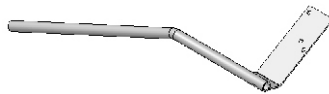

(1)
A0273
BOX HANDLE

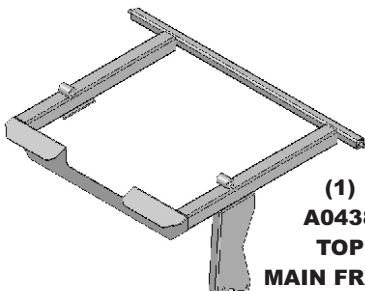

(1)
A0438
TOP
MAIN FRAME
ASSY.

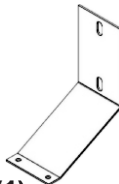

(1)
B0276
AIR CLEANER
MOUNT BRACE

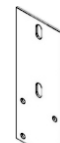

(1)
B0275
AIR CLEANER
MOUNT PLATE



(1)
A0437 LEFT
LOWER MAIN FRAME
LEG ASSEMBLY

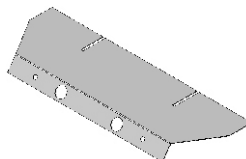

(1)
C0011
HEAT GUARD



(1)
B0079
BOOT PLATE

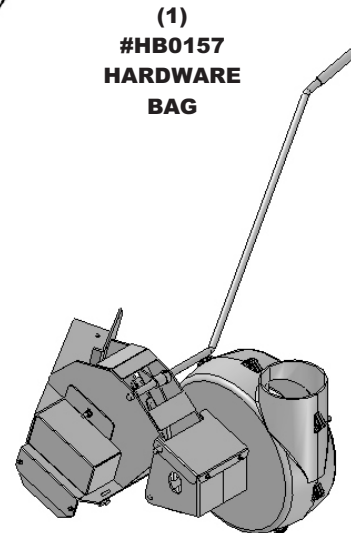

(1)
A0421
PTO ASSEMBLY

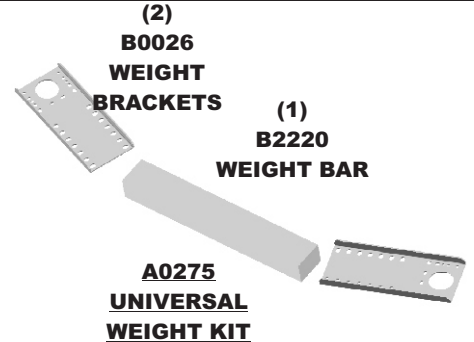

(2)
B0026
WEIGHT
BRACKETS
(1)
B2220
WEIGHT BAR

A0275
UNIVERSAL
WEIGHT KIT



(1)
#HB0157
HARDWARE
BAG



(1)
E6009
8" BLOWER
CONE

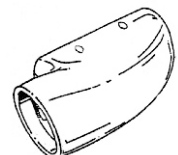

(1)
E1030
BOOT