

**MODEL#: 39621226**



**MOWER NAME: GREAT DANE**

**MOWER MODEL: CHARIOT - KOHLER 25 HP**

**MOWER DECK SIZE: 61"**

**VAC NAME: 12 CUBIC FOOT BOX**

**FOR YEAR: 2005 - 2003**

**REVISED: 04/26/2006**

**NOTE: WILL ONLY FIT CHARIOT MOWER WITH A KOHLER ENGINE**

**WAS  
396212-PTO-04(25KH)**

**A0521 12 PTO UNIT ASSEMBLY**

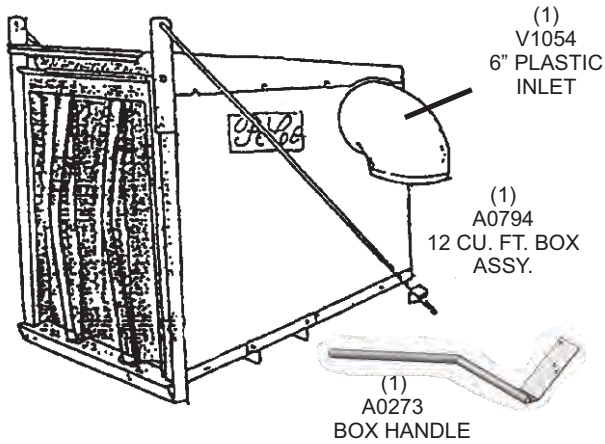

(1) 6" x 38" UPPER HOSE



(1) 8" x 38" LOWER HOSE



(2) J0060 6" HOSE CLAMPS



(2) J0080 8" HOSE CLAMPS



(1) HB0195 HARDWARE BAG



(1) HB0198 ENGINE PULLEY HARDWARE BAG

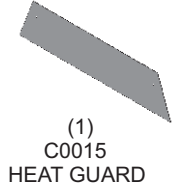

(1) C0015 HEAT GUARD

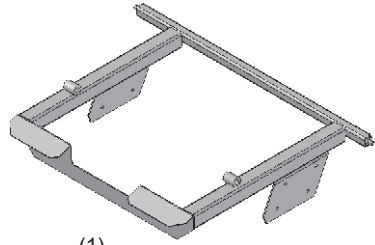

(1) A0452 TOP MAIN FRAME ASSEMBLY



(1) B0064 LEFT LOWER MAIN FRAME LEG

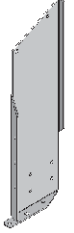

(1) B0149 RIGHT LOWER MAIN FRAME LEG

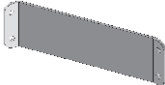

(1) B0153 PTO ARM BRACE



(1) E6009 8" BLOWER CONE

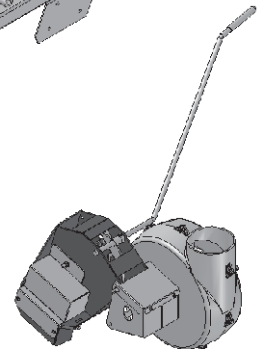

A0537 PTO ASSEMBLY

**A0508-UNIVERSAL WEIGHT KIT**

(2) B0026 WEIGHT BRACKETS

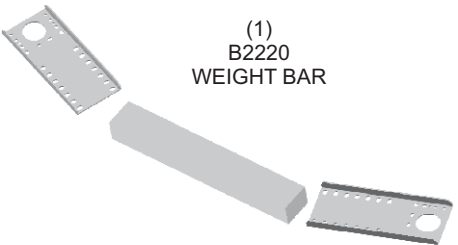

(1) B2220 WEIGHT BAR



(1) HB0183 HARDWARE BAG

**A0534-61" BOOT KIT**



(1) HB0194 HARDWARE BAG

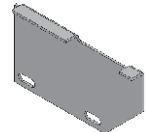

(1) B0088 BOOT PLATE

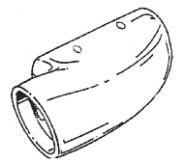

(1) E1030 BOOT