

**MODEL#: 39621224**

**MOWER NAME: GREAT DANE**

**MOWER MODEL: CHARIOT - KOHLER 25 HP**

**MOWER DECK SIZE: 52"**

**VAC NAME: 12 CUBIC FOOT BOX**



**NOTE: WILL ONLY FIT CHARIOT MOWER WITH A KOHLER ENGINE**



FOR YEAR: 2005 - 2003

REVISED: 04/26/06

WAS  
396212-PTO-04 (25KH)

**A0521 12 PTO UNIT ASSEMBLY**

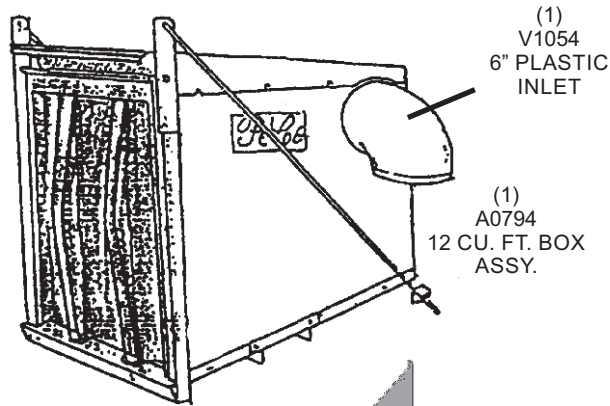

(1)  
6" x 38"  
UPPER  
HOSE



(1)  
7" x 38"  
LOWER  
HOSE



(2)  
J0060  
6" HOSE  
CLAMPS



(2)  
J0070  
7" HOSE  
CLAMPS



(1)  
HB0195  
HARDWARE  
BAG



(1)  
HB0198  
ENGINE PULLEY  
HARDWARE  
BAG

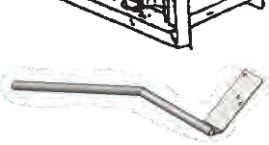

(1)  
A0273  
BOX HANDLE



(1)  
B0064 LEFT  
LOWER MAIN FRAME LEG



(1)  
B0149 RIGHT  
LOWER MAIN FRAME LEG

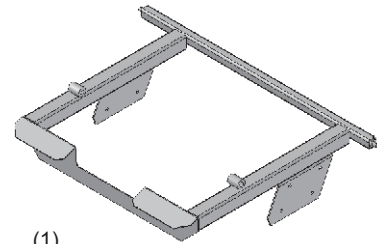

(1)  
A0452  
TOP MAIN FRAME  
ASSEMBLY

**A0508-UNIVERSAL WEIGHT KIT**

(2)  
B0026  
WEIGHT  
BRACKETS

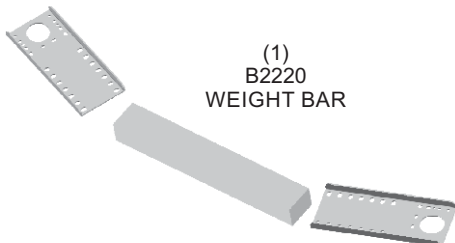

(1)  
B2220  
WEIGHT BAR



(1)  
HB0183  
HARDWARE  
BAG

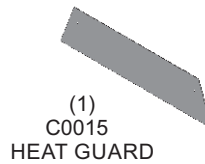

(1)  
C0015  
HEAT GUARD



(1)  
E6004  
7" BLOWER  
CONE

**A0535-52" BOOT KIT**



(1)  
HB0194  
HARDWARE BAG

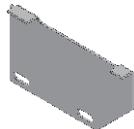

(1)  
B0096  
BOOT PLATE

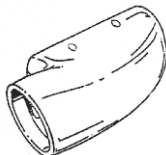

(1)  
E1031  
BOOT



(1)  
B0153  
PTO ARM BRACE

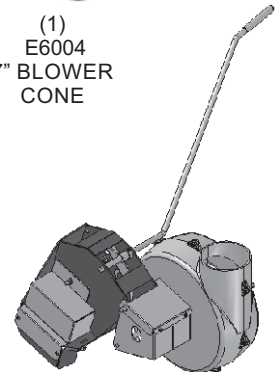

(1)  
A0537  
PTO ASSEMBLY