

MODEL#: 39621215

MOWER NAME: GREAT DANE CHARIOT JR.

MOWER MODEL: GDRZ52-23KAE

MOWER DECK SIZE: 52" DECK

VAC NAME: 12 CUBIC FOOT BOX

ENG: 900 SER. BR (9.00 GROSS TORQUE / 205 cc)

NOTE: USE A0972 MAIN FRAME ASSEMBLIES UNTIL STOCK IS DEPLETED



FOR YEAR: 2002 & BELOW

REVISED: 5/8/2012

WAS
396212-JR-02

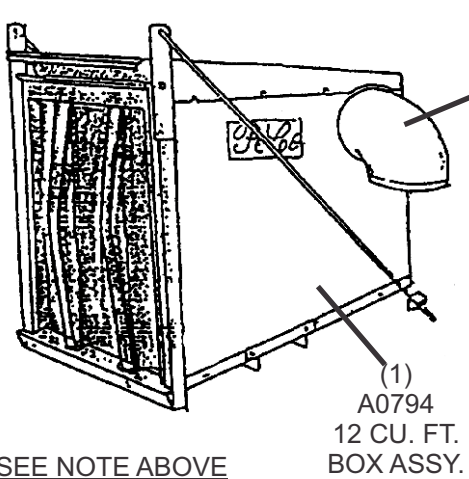

(1)
V1054
6" PLASTIC
INLET

(1)
B3727
OUTER MOTOR
MOUNT TUBE

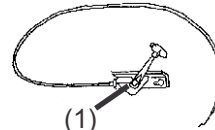

(1)
A0060
SHORT THROTTLE
KIT FOR 900 SERIES



(1)
#A08227
HARDWARE
BAG

SEE NOTE ABOVE
BEFORE PACKING!

(1)
A0413
TOP FRAME
ASSY.

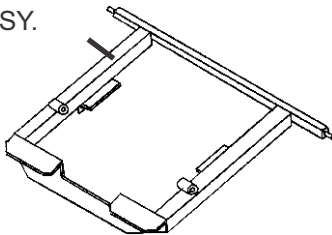

(1)
6" x 26"
UPPER
HOSE

(1)
7" x 32"
LOWER
HOSE

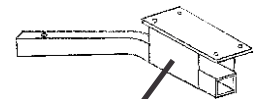

(1)
A0971
MOTOR MOUNT
ARM ASSY.

(1)
B3805
BOOT PLATE

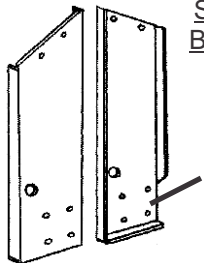

SEE NOTE ABOVE
BEFORE PACKING!

(2)
B0064
LEFT & RIGHT
SIDE LEGS

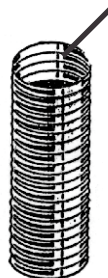
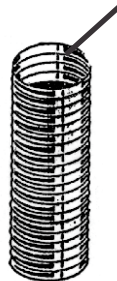

(1)
A0978
WEIGHT ASSY.



(1)
ENGINE/
BLOWER/
BLADE ASSY.

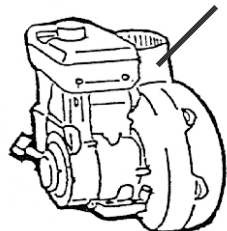

(1)
E6004
7" BLOWER
CONE

(2)
J6006
7" - 8"
HOSE CLAMPS

(1)
E1036
BOOT

