

MODEL#: 39621207

MOWER NAME: GREAT DANE CHARIOT

MOWER MODEL: GDRZ61-26KHE

MOWER DECK SIZE: 61"

VAC NAME: 12 CUBIC FOOT BOX

ENG: 900 SER. BR (9.00 GROSS TORQUE / 205 cc)

NOTE: USE A0972 MAIN FRAME ASSEMBLIES UNTIL STOCK IS DEPLETED

NOTE: WILL NOT FIT MOWERS EQUIPPED WITH THE DONALDSON AIR CLEANER



FOR YEAR: 2002 & BELOW

REVISED: 5/8/2012

**WAS
396212-EFI-02**

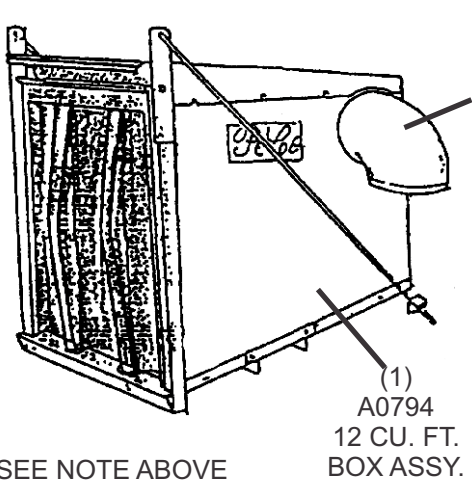

(1)
V1054
6" PLASTIC
INLET

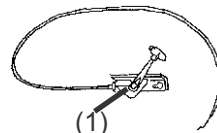

(1)
A0060
SHORT THROTTLE KIT
FOR (900 SERIES)



(1)
#HB0117
HARDWARE
BAG

(1)
B3727
OUTER MOTOR
MOUNT TUBE

(1)
A0794
12 CU. FT.
BOX ASSY.

**SEE NOTE ABOVE
BEFORE PACKING!**

(1)
A0413
TOP FRAME
ASSY.

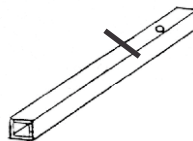
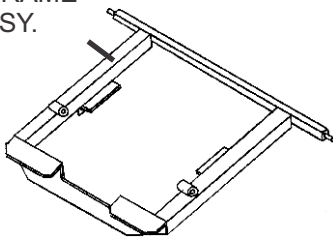

(1)
6" x 38"
UPPER
HOSE

(1)
A0907
WEIGHT
ASSEMBLY

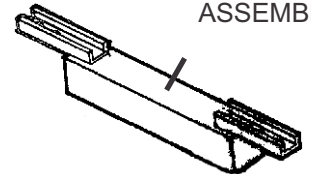

(1)
8" x 36"
LOWER
HOSE



**SEE NOTE ABOVE
BEFORE PACKING!**

(2)
B0064
LEFT & RIGHT
SIDE LEGS

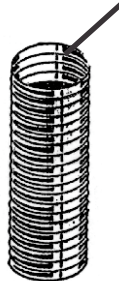
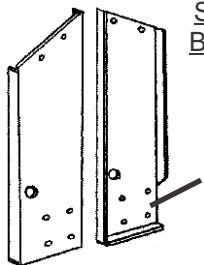

(1)
B3805
BOOT
PLATE

(1)
ENGINE/
BLOWER/
BLADE ASSY.

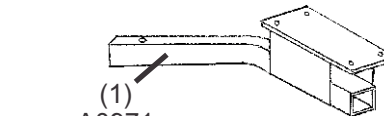
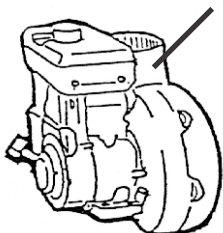

(1)
A0971
MOTOR MOUNT
ARM ASSEMBLY

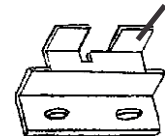

(1)
E1042
BOOT

(1)
E6009
8" BLOWER
CONE



(2)
J6006
7" - 8"
HOSE CLAMPS

