

# MODEL#: 39621236

MOWER NAME: GREAT DANE CHARIOT JR.

MOWER MODEL: GDRZ52-23KAE

MOWER DECK SIZE: 52" DECK

VAC NAME: 12 CUBIC FOOT BOX



6.5HP BRIGGS AND STRATTON VANGUARD

**NOTE: USE A0972 MAIN FRAME ASSEMBLIES UNTIL STOCK IS DEPLETED**



FOR YEAR: 2002 & BELOW

REVISED: 12/19/11

WAS

396212-JR-02

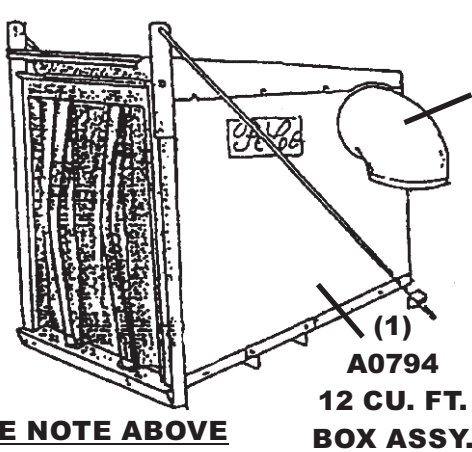

(1)  
V1054  
6"  
PLASTIC  
INLET

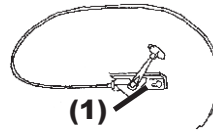

(1)  
A0060  
70" THROTTLE KIT  
FOR (5.5 & 6.5HP)



(1)  
#A08227  
HARDWARE  
BAG

SEE NOTE ABOVE  
BEFORE PACKING!

(1)  
A0794  
12 CU. FT.  
BOX ASSY.

(1)  
B3727  
OUTER MOTOR  
MOUNT TUBE

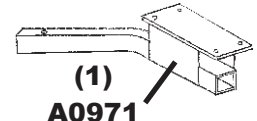

(1)  
A0971  
MOTOR MOUNT  
ARM ASSY.

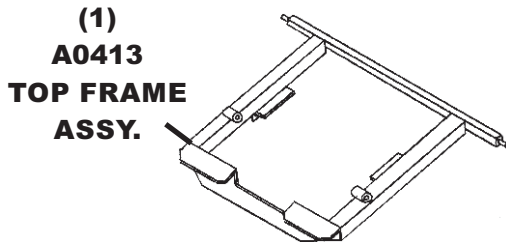

(1)  
A0413  
TOP FRAME  
ASSY.

(1)  
6" x 26"  
UPPER  
HOSE

(1)  
7" x 32"  
LOWER  
HOSE

(1)  
B3805  
BOOT PLATE



SEE NOTE ABOVE  
BEFORE  
PACKING!

(2)  
B0064  
LEFT & RIGHT  
SIDE LEGS



(1)  
E6004  
7" BLOWER  
CONE



(2)  
J0060  
6" HOSE  
CLAMPS



(2)  
J0070  
7" HOSE  
CLAMPS

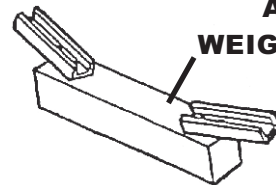

(1)  
A0978  
WEIGHT ASSY.

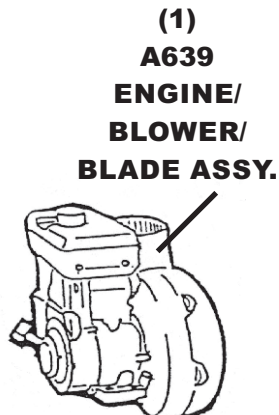

(1)  
A639  
ENGINE/  
BLOWER/  
BLADE ASSY.

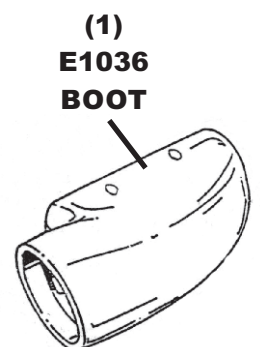

(1)  
E1036  
BOOT