

MODEL#: 39621234

MOWER NAME: GREAT DANE CHARIOT JR.

MOWER MODEL: GDRZ48-19KAE

MOWER DECK SIZE: 48" DECK

VAC NAME: 12 CUBIC FOOT BOX



6.5HP BRIGGS AND STRATTON VANGUARD

NOTE: USE A0972 MAIN FRAME ASSEMBLIES UNTIL STOCK IS DEPLETED



FOR YEAR: 2002 & BELOW

REVISED: 12/19/11

WAS

396212-JR-02

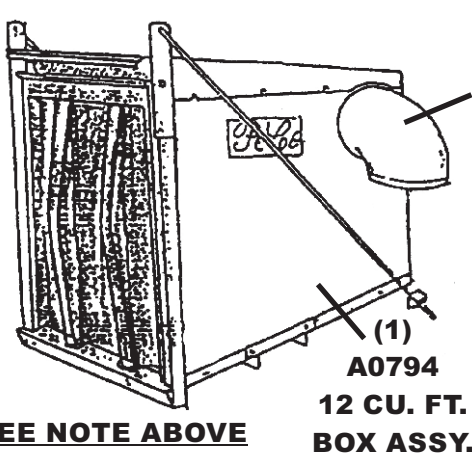

(1)
V1054
6"
PLASTIC
INLET

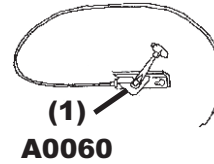

(1)
A0060
70" THROTTLE KIT
FOR (5.5 & 6.5HP)



(1)
#A08227
HARDWARE
BAG

(1)
B3727
OUTER MOTOR
MOUNT TUBE

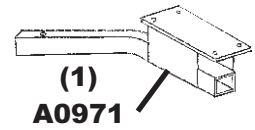

(1)
A0971
MOTOR MOUNT
ARM ASSY.

**SEE NOTE ABOVE
BEFORE PACKING!**

(1)
A0413
TOP FRAME
ASSY.

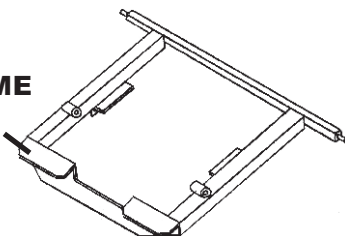

(1)
B3805
BOOT PLATE

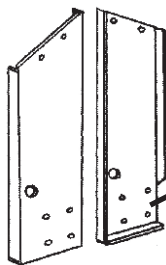

**SEE NOTE ABOVE
BEFORE
PACKING!**

(2)
B0064
LEFT & RIGHT
SIDE LEGS

(1)
6" x 26"
UPPER
HOSE



(1)
7" x 32"
LOWER
HOSE

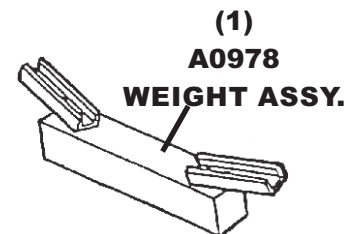

(1)
A0978
WEIGHT ASSY.

(1)
A639
ENGINE/
BLOWER/
BLADE ASSY.

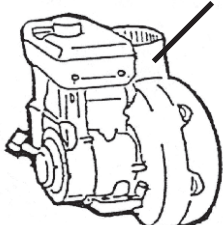

(1)
E6004
7" BLOWER
CONE



(2)
J0060
6" Hose
Clamps



(2)
J0070
7" Hose
Clamps

(1)
E1041
BOOT

