

# MODEL#: 12621220

MOWER NAME: GRAVELY PROMASTER

MOWER MODEL: PM 260Z & PM 270Z

MOWER DECK SIZE: (60" DECK)

VAC NAME: 12 CUBIC FOOT BOX

6.5HP BRIGGS AND STRATTON VANGUARD

**NOTE:**



FOR YEAR: 2000-2001

REVISED: 12/19/11

WAS - 126212-PM260-01 &  
126212-PM270-01

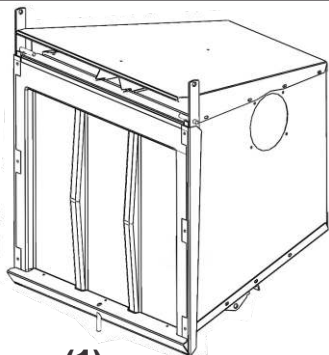

(1)  
**A0794**  
12 CU. FT.  
BOX ASSY.



(1)  
**E8010**  
HOSE  
RING



(1)  
**V1052**  
INLET W/  
LOCKING PIN



(1)  
**8" x 36"**  
LOWER  
HOSE



(1)  
**6" x 52"**  
UPPER  
HOSE

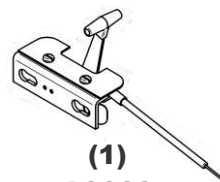

(1)  
**A0060**  
LONG THROTTLE KIT  
FOR (5.5 & 6.5HP)

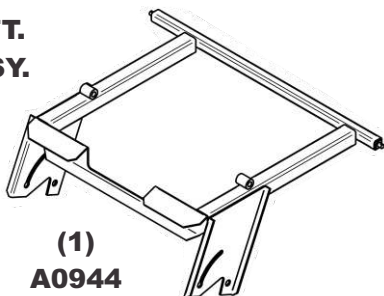

(1)  
**A0944**  
MAIN FRAME  
ASSY.

(2)  
**B2583**  
MOUNTING  
BRACKETS

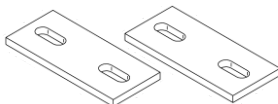

(1)  
**A0231**  
LEFT SIDE  
LEG ASSY.



(1)  
**A0981**  
RIGHT SIDE  
LEG ASSY.



(1)  
**#HB0040**  
HARDWARE  
BAG

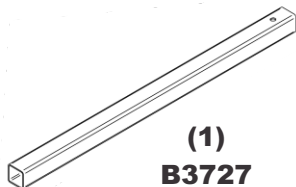

(1)  
**B3727**  
OUTER MOTOR  
MOUNT TUBE

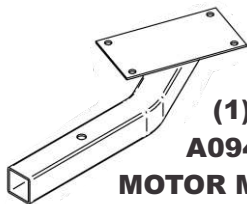

(1)  
**A0943**  
MOTOR MOUNT  
ARM ASSY.



(1)  
**B2540**  
BOOT  
ROD

(1)  
**B2540**  
BOOT  
ROD

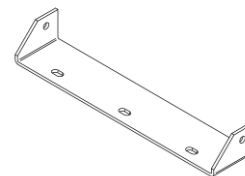

(1)  
**B2539**  
BOOT  
PLATE

(1)  
**A639**  
ENGINE/  
BLOWER/  
BLADE ASSY.

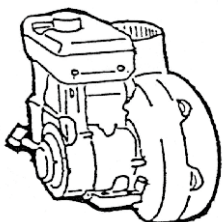

(1)  
**E1034**  
BOOT

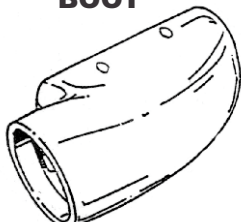

(1)  
**E6009**  
8" BLOWER  
CONE



(2)  
**J6006**  
7" - 8"  
HOSE CLAMPS



(2)  
**A0982**  
WEIGHT  
ASSY.

