

MODEL#: 12621208

MOWER NAME: GRAVELY PROMASTER

MOWER MODEL: PM 260Z & PM 270Z

MOWER DECK SIZE: (72" DECK)

VAC NAME: 12 CUBIC FOOT BOX

ENG: 1450 SER. BR (14.50 GROSS TORQUE / 305 cc)

NOTE:



FOR YEAR: 2000-2001

REVISED: 5/8/2012

WAS - 126212-PM260-01 & 126212-PM270-01

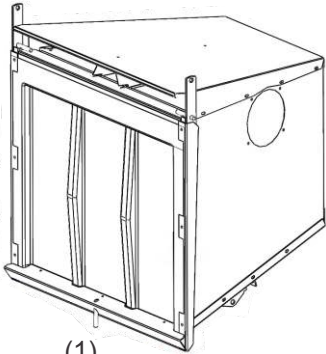

(1)
A0794
12 CU. FT.
BOX ASSY.



(1)
E9003
HOSE
RING



(1)
V1152
INLET W/
LOCKING PIN



(1)
9" x 36"
LOWER
HOSE



(1)
7" x 52"
UPPER
HOSE

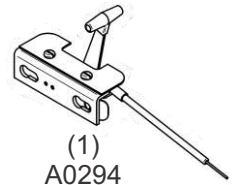

(1)
A0294
LONG THROTTLE KIT
FOR (1450 SERIES)

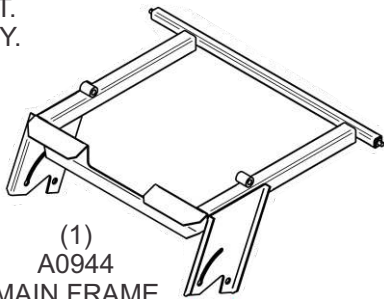

(1)
A0944
MAIN FRAME
ASSY.

(2)
B2583
MOUNTING
BRACKETS

(1)
A0231
LEFT SIDE
LEG ASSY.

(1)
A0981
RIGHT SIDE
LEG ASSY.



(1)
#HB0040
HARDWARE
BAG

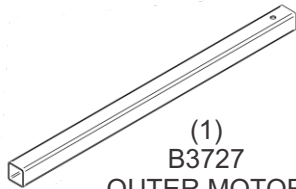

(1)
B3727
OUTER MOTOR
MOUNT TUBE

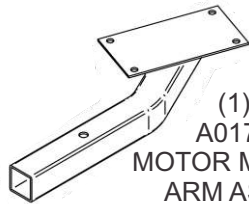

(1)
A0177
MOTOR MOUNT
ARM ASSY.

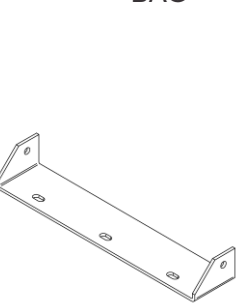

(1)
B2539
BOOT PLATE



(1)
B2540
BOOT
ROD

(1)
ENGINE/
BLOWER/
BLADE ASSY.

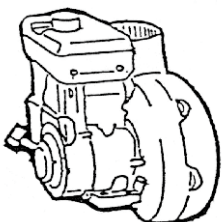

(1)
E1118
BOOT

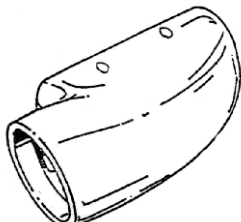

(1)
E6012
9" BLOWER
CONE



(2)
J6006
7" - 8"
HOSE CLAMPS



(2)
A0982
WEIGHT
ASSY.

