

MODEL#: 22020902

MOWER NAME: TORO

MOWER MODEL: TITAN MX SERIES

MOWER DECK SIZE: 48" 54" AND 60" DECKS

VAC NAME: PRO 2 BAGGER

PTO DRIVEN

MANUAL #Q0405

A1797 UNIT ASSEMBLY



FOR YEAR: 2011 - 2012

REVISED: 6/27/2012

FITS
THESE
MOWER
MODELS:

2011 - 2012 74871 (MX4880) 74872 (MX5480)
& 74873 (MX6080)

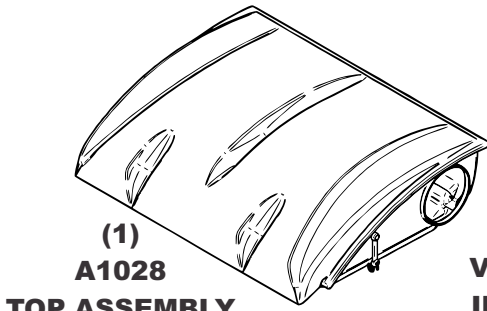

(1)
A1028
TOP ASSEMBLY

(1)
V0019
INLET



(4)
J1000
HOSE
CLAMPS

(1)
F0060
6" x 22"

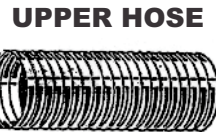

UPPER HOSE

(1)
F0060
6" x 30"

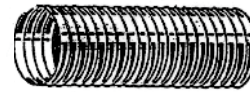

LOWER HOSE



(1)
HB0442
UNIT
HARDWARE
BAG

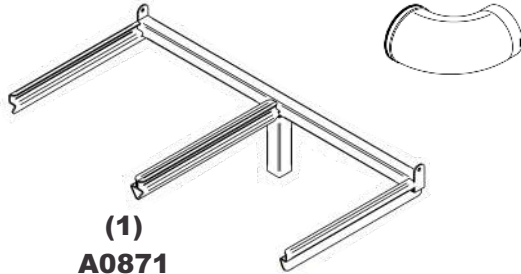

(1)
A0871
UPPER FRAME
ASSEMBLY

(1)
A1022
LOWER FRAME
ASSEMBLY

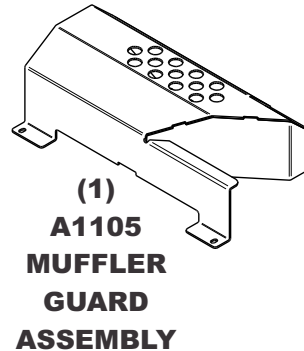

(1)
A1105
MUFFLER
GUARD
ASSEMBLY



(1)
M0254
A59K KEVLAR
BELT



(1)
HB0443
ENGINE
PULLEY
HARDWARE
BAG

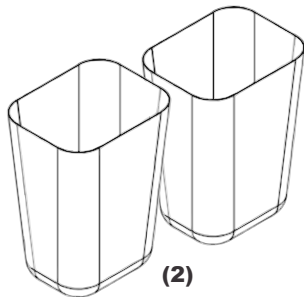

(2)
G0004
2.9 CU. FT.
COLLECTION
BAGS

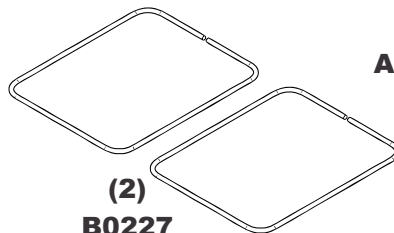

(2)
B0227
BAG RING

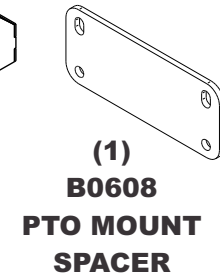

(1)
B0608
PTO MOUNT
SPACER

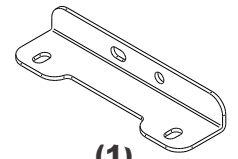

(1)
B0606
LOWER FRAME
MOUNT

A1781 BOOT KIT



(1)
HB0418
HARDWARE
BAG

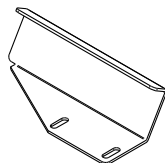

(1)
B0605
BOOT
PLATE

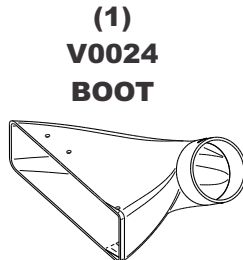

(1)
V0024
BOOT

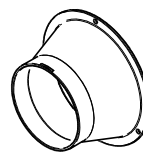

(1)
V0016
BLOWER
CONE 6"

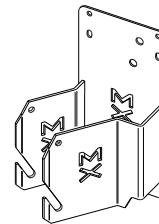

(1)
A1795
PTO MOUNT
ASSEMBLY

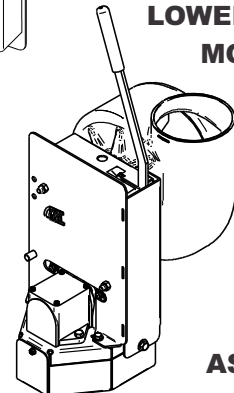

(1)
A1111
PTO
ASSEMBLY