

MODEL#: 21031202

MOWER NAME: CUB CADET

MOWER MODEL: TANK W/ 19HP KW

MOWER DECK SIZE: 48", 54" & 60"

VAC NAME: 12 CUBIC FOOT PRO BAGGER

PTO DRIVEN

BOM0314



FOR YEAR: 2006 - 2008

REVISED:

A0888 UNIT ASSEMBLY

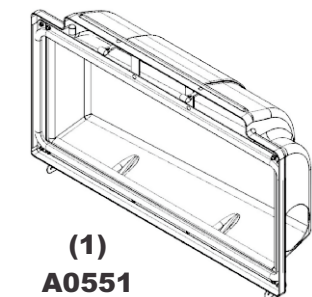

(1)
A0551
TOP
ASSEMBLY



(1)
V1054
6" PLASTIC
INLET

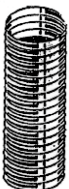

(1)
7" x 35"
LOWER
HOSE



(1)
6" x 21"
UPPER
HOSE



(4)
J1000
2" - 10"
HOSE
CLAMPS

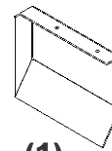

(1)
C0058
EXHAUST
DEFLECTOR



(1)
HB0325
HARDWARE
BAG



(1)
HB0318
ENGINE
PULLEY
HARDWARE
BAG

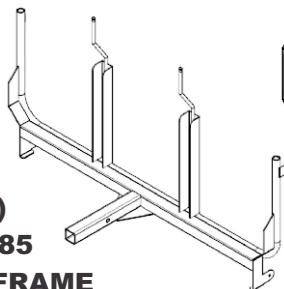

(1)
A0585
UPPER FRAME
ASSEMBLY

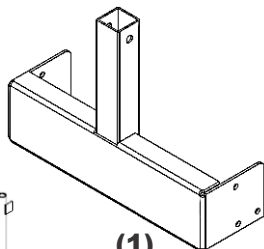

(1)
A0848
LWR. MNT
ASSY.

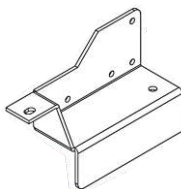

(1)
B0395
LT. LWR.
MOUNT PL.

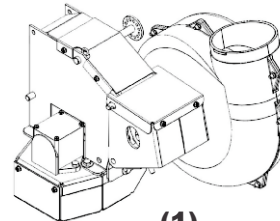

(1)
A0623
PTO
ASSEMBLY

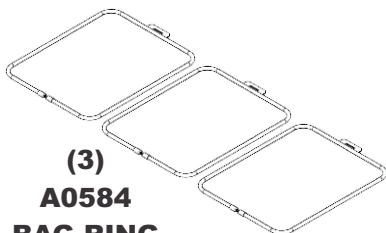

(3)
A0584
BAG RING
ASSEMBLY

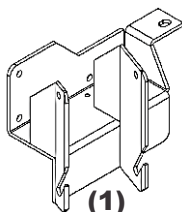

(1)
A0846
PTO MOUNT
PLATE ASSY.



(1)
E6004
7" BLOWER
CONE

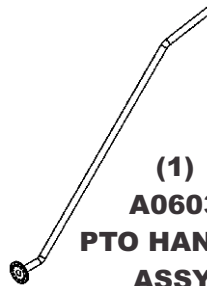

(1)
A0603
PTO HANDLE
ASSY.

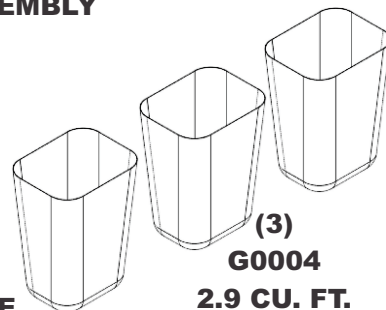

(3)
G0004
2.9 CU. FT.
COLLECTION
BAGS

A0689 - WEIGHT KIT

(2)
B0026
WEIGHT
BRACKETS

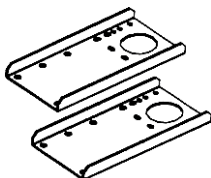

(1)
HB0314
HARDWARE
BAG



(1)
B2220
WEIGHT

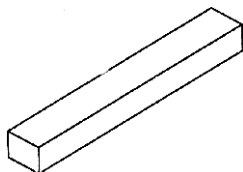

A0690 - BOOT KIT

(1)
HB0078
HARDWARE
BAG



(1)
B4331
BOOT ROD

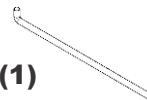

(1)
B2555
BOOT
PLATE

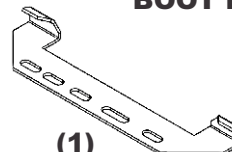

(1)
E1031
BOOT

