

MODEL#: 21031203

MOWER NAME: CUB CADET

MOWER MODEL: TANK

MOWER DECK SIZE: 48" 54" & 60"

VAC NAME: 12 CUBIC FOOT PRO BAGGER

ENG: 900 SER. BR (9.00 GROSS TORQUE / 205 cc)

BOM0326



FOR YEAR: 2006 - 2008

REVISED: 5/10/2012

A0926 UNIT ASSEMBLY

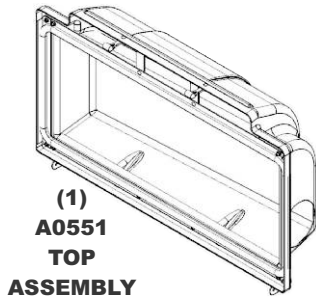

(1)
A0551
TOP
ASSEMBLY



(1)
V1054
6" PLASTIC
INLET

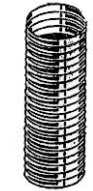

(1)
7" x 35"
LOWER
HOSE



(1)
6" x 21"
UPPER
HOSE

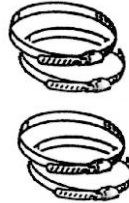

(4)
J1000
HOSE
CLAMPS

A0619 THROTTLE KIT

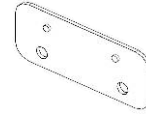

(1)
A0666
THROTTLE
MNT. PL.
ASSY.



(1)
A0060
70" THROTTLE
KIT
FOR (900 SERIES)



(1)
HB0249
HARDWARE
BAG

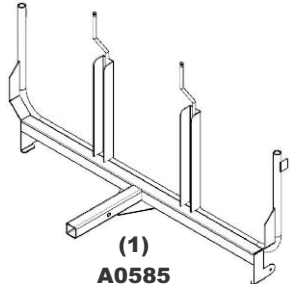

(1)
A0585
UPPER FRAME
ASSEMBLY

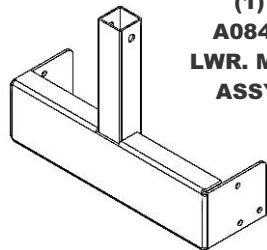

(1)
A0848
LWR. MNT.
ASSY.

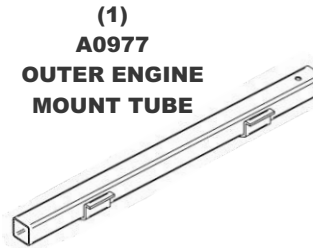

(1)
A0977
OUTER ENGINE
MOUNT TUBE



(1)
HB0343
HARDWARE
BAG

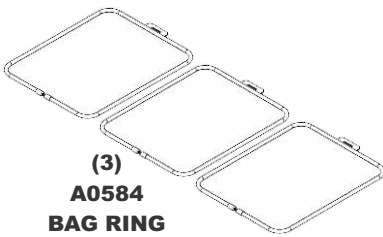

(3)
A0584
BAG RING
ASSEMBLY

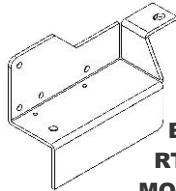

(1)
B0396
RT. LWR.
MOUNT PL.

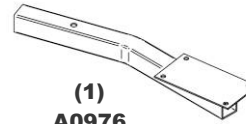

(1)
A0976
ENGINE MNT.
ARM ASSY.

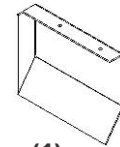

(1)
C0058
EXHAUST
DEFLECTOR

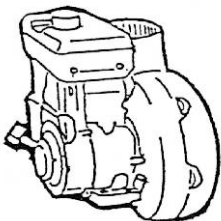

(1)
ENGINE/
BLOWER/
BLADE ASSY.

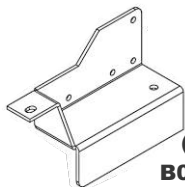

(1)
B0395
LT. LWR.
MOUNT PL.



(1)
E6004
7" BLOWER
CONE

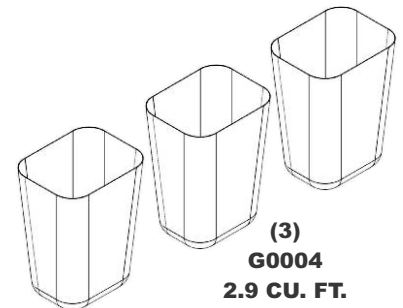

(3)
G0004
2.9 CU. FT.
COLLECTION
BAGS

A0689 - WEIGHT KIT

(2)
B0026
WEIGHT
BRACKETS



(1)
HB0314
HARDWARE
BAG



(1)
B2220
WEIGHT

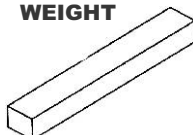

A0690 - BOOT KIT



(1)
HB0078
HARDWARE
BAG

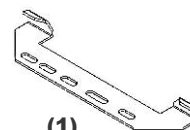

(1)
B2555
BOOT
PLATE

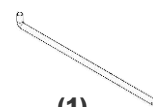

(1)
B4331
BOOT ROD

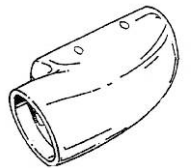

(1)
E1031
BOOT