

MODEL#: 06031501

MOWER NAME: JOHN DEERE

MOWER MODEL: 737, 757, 777 & 797 W/ ROPS

MOWER DECK SIZE: 60" 7-IRON COMMERCIAL

VAC NAME: 15 CUBIC FOOT PRO BAGGER

ENG: 900 SER. BR (9.00 GROSS TORQUE / 205 cc)

BOM0300



FOR YEAR: 2007 - 2005

REVISED: 5/10/2012

A0740 UNIT ASSEMBLY

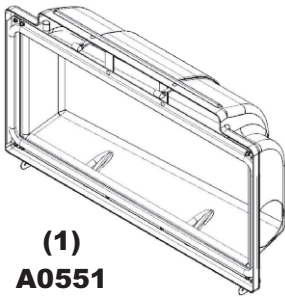

(1)
**A0551
TOP
ASSEMBLY**



(1)
**V1054
6" PLASTIC
INLET**



(1)
**9" x 44"
LOWER
HOSE**



(1)
**6" x 38"
UPPER
HOSE**

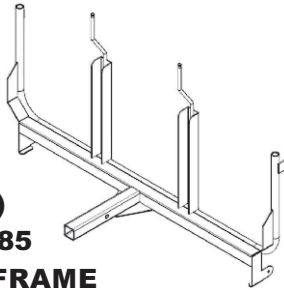

(1)
**A0585
UPPER FRAME
ASSEMBLY**

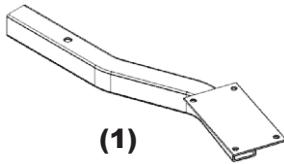

(1)
**A0019
ENGINE MNT.
ARM ASSY.**

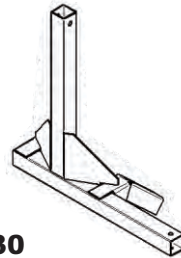

(1)
**A0730
LWR. MNT
ASSY.**



(1)
**E6020
9" BLOWER
CONE**



(1)
**#HB0306
HARDWAR
E**

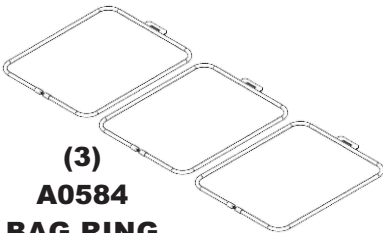

(3)
**A0584
BAG RING
ASSEMBLY**



(2)
**J0060
6" Hose
Clamps**



(2)
**J0090
9" Hose
Clamps**

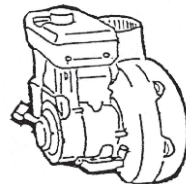

(1)
**ENGINE/
BLOWER/
BLADE ASSY.**

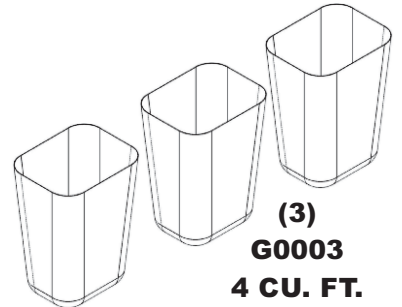

(3)
**G0003
4 CU. FT.
COLLECTION
BAGS**

A0586 - WEIGHT KIT

(2)
**B0026
WEIGHT
BRACKETS**

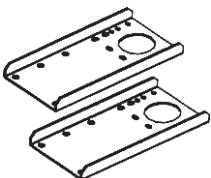

(1)
**#HB0136
HARDWAR
E**



(1)
**B2220
WEIGHT**

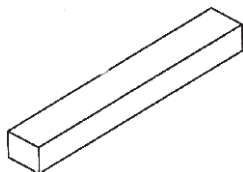

A0583 - 60" BOOT KIT

(1)
**#HB0218
HARDWAR
E**



(1)
**B1856
BOOT
PLATE**

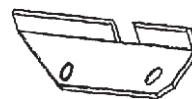

(1)
**E1129
BOOT**

