

MODEL#: 06031507

MOWER NAME: JOHN DEERE

MOWER MODEL: 737, 757, 777 & 797 W/ ROPS

MOWER DECK SIZE: 60" 7-IRON COMMERCIAL

VAC NAME: 15 CUBIC FOOT PRO BAGGER

6.5 BRIGGS AND STRATTON VANGUARD

BOM0301



FOR YEAR: 2007 - 2005

REVISED: 12/20/11

A0741 UNIT ASSEMBLY

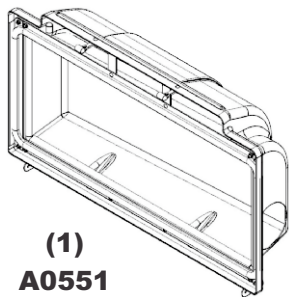

(1)
A0551
TOP
ASSEMBLY



(1)
V1054
6" PLASTIC
INLET



(1)
9" x 44"
LOWER
HOSE



(1)
6" x 38"
UPPER
HOSE

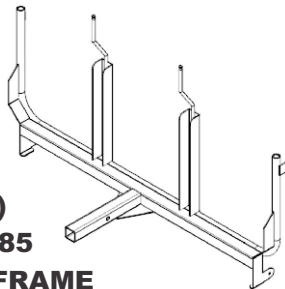

(1)
A0585
UPPER FRAME
ASSEMBLY



(2)
J6009
9" - 10"
HOSE CLAMPS



(1)
A0730
LWR. MNT
ASSY.



(1)
E6020
9" BLOWER
CONE



(1)
#HB0306
HARDWARE
BAG

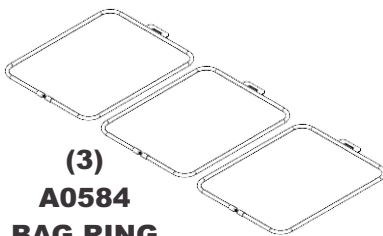

(3)
A0584
BAG RING
ASSEMBLY

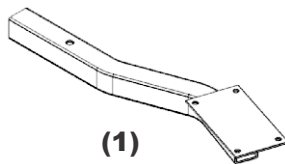

(1)
A0019
ENGINE MNT.
ARM ASSY.

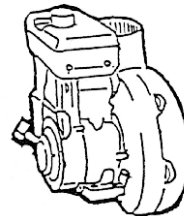

(1)
A639
ENGINE/
BLOWER/
BLADE ASSY.

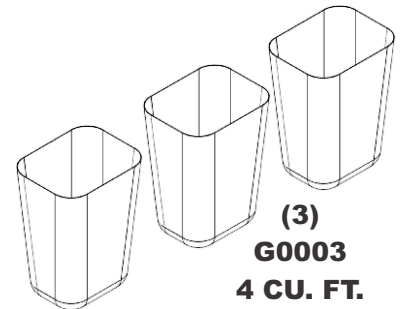

(3)
G0003
4 CU. FT.
COLLECTION
BAGS

A0586 - WEIGHT KIT

(2)
B0026
WEIGHT
BRACKETS

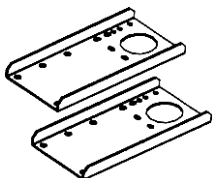

(1)
#HB0136
HARDWARE
BAG



(1)
B2220
WEIGHT

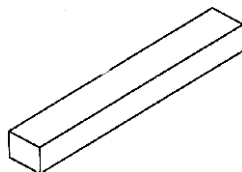

A0583 - 60" BOOT KIT

(1)
#HB0218
HARDWARE
BAG



(1)
B1856
BOOT
PLATE

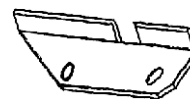

(1)
E1129
BOOT

