

MODEL#: 35031504

MOWER NAME: EXMARK

MOWER MODEL: NEW GENERATION LAZER Z

MOWER DECK SIZE: 52"

VAC NAME: 15 CUBIC FOOT PRO BAGGER

DECK DRIVE

MANUAL: #Q0400

A1754 UNIT ASSEMBLY



FOR YEAR: 2010

REVISED:

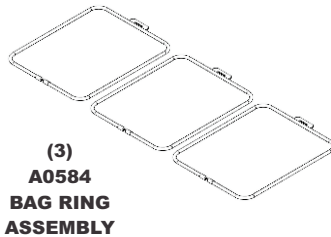
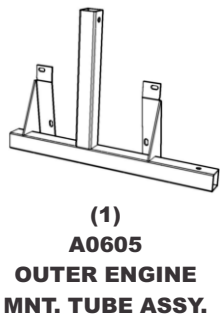
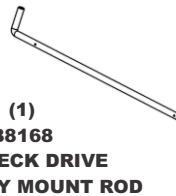
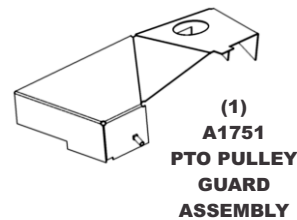
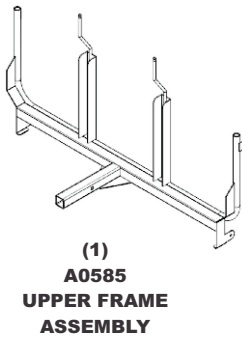
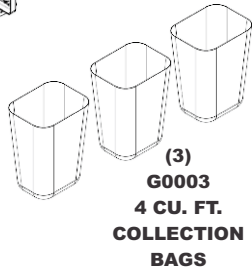
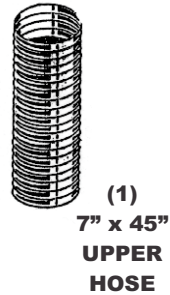
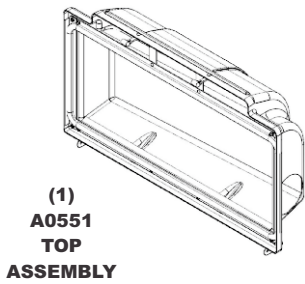

A1055 - PTO DECK DRIVE ASSEMBLY

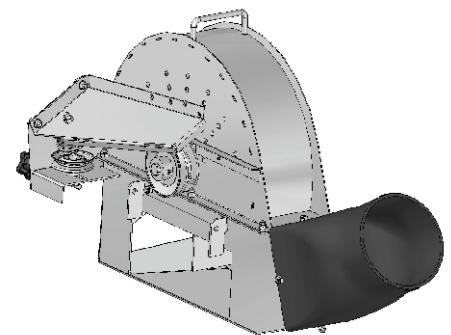

A0665 - WEIGHT KIT

