

MODEL#: 35621220

MOWER NAME: EXMARK

MOWER MODEL: LAZER Z NEXT GENERATION

MOWER DECK SIZE: 52"

VAC NAME: 12 CUBIC FOOT BOX

PTO DECK DRIVE

MANUAL: Q0399



FOR YEAR: 2010

REVISED:

A1752 - UNIT ASSEMBLY

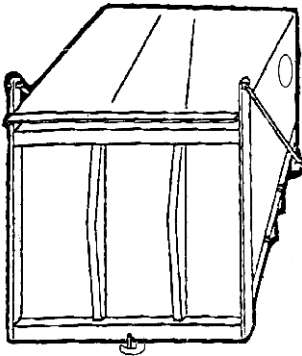

(1)
A0794
12 CU. FT. BOX
ASSEMBLY



(1)
7" x 45"
UPPER
HOSE



(2)
J1000
HOSE
CLAMPS



(1)
HB0405
HARDWARE
BAG



(1)
V1054
INLET

(1) B0529 LEFT &
(1) B0528 RIGHT
LOWER MAIN
FRAME LEGS

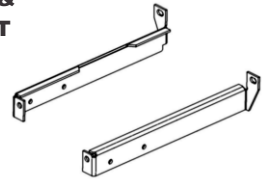

(1)
A0601
MAIN FRAME
ASSEMBLY

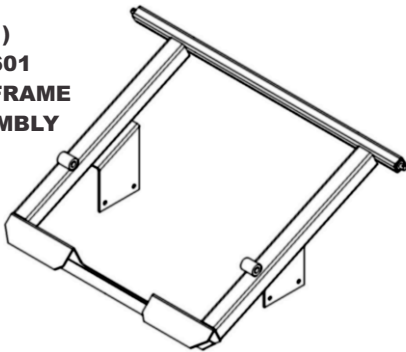

(1)
A0273
BOX HANDLE

A1055 - PTO DECK DRIVE ASSEMBLY

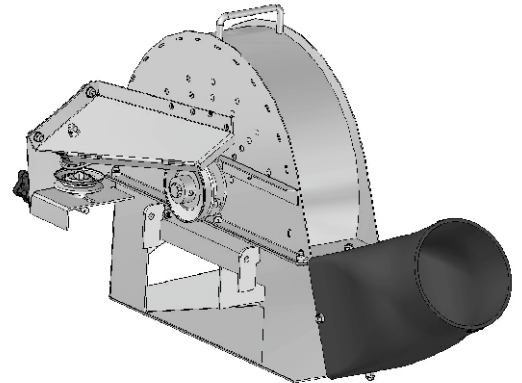

(2)
B2526
DOOR LINKAGE



(1)
M0306
A64K KEVLAR
BELT

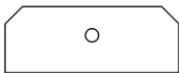

(1)
B0586
PULLEY
GUARD CLAMP

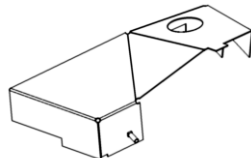

(1)
A1751
PTO PULLEY
GUARD
ASSEMBLY

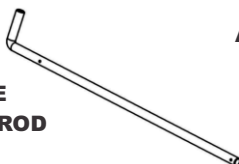

(1)
B8168
PTO DECK DRIVE
ASSEMBLY MOUNT ROD

A0665 - WEIGHT KIT

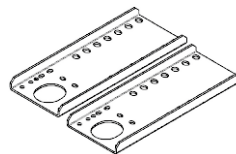

(2)
B0026
WEIGHT
BRACKETS

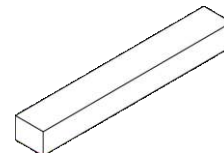

(1)
B2220
WEIGHT BAR



(1)
HB0370
HARDWARE
BAG