

MODEL#: 35621213

MOWER NAME: EXMARK LAZER Z HP

MOWER MODEL: (LZHP4417KA, LZHP4420KC,
LZHP4820KC, & LZHP4821KA)

MOWER DECK SIZE: (44" & 48" DECK)

VAC NAME: 12 CUBIC FOOT BOX

ENG: 900 SER. BR (9.00 GROSS TORQUE / 205 cc)



NOTE: SEE THROTTLE KIT & WEIGHT NOTES BELOW



FOR YEAR: 2002 - 2003

REVISED: 5/8/2012

WAS

356212-HP-03

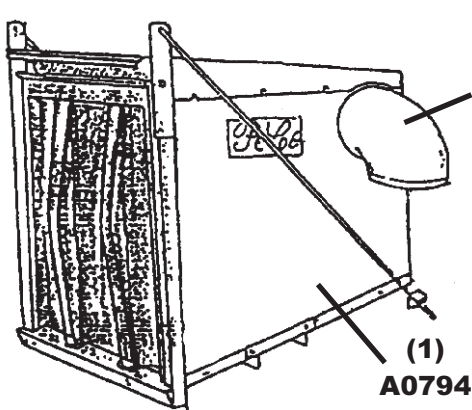

(1)
V1054
6"
PLASTIC
INLET

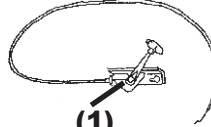

(1)
A0060
THROTTLE CABLE
KIT (70")



(1)
#HB0147
HARDWARE
BAG

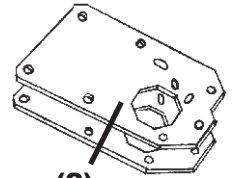

(2)
B0039
WEIGHT
BRACKETS

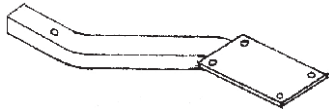

(1)
A0318
MOTOR MOUNT
ARM ASSEMBLY

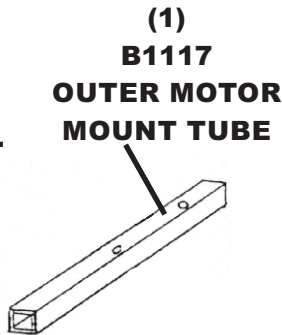

(1)
B1117
OUTER MOTOR
MOUNT TUBE

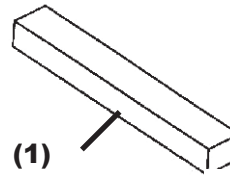

(1)
B2220
WEIGHT

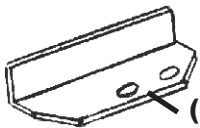

(1)
B0063
BOOT PLATE



(1)
6" x 29"
UPPER
HOSE



(1)
7" x 39"
LOWER
HOSE

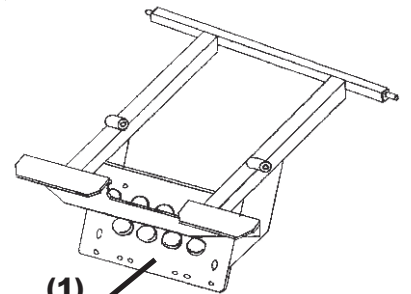

(1)
A0403
MAIN FRAME
ASSY.

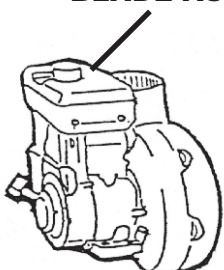

(1)
ENGINE/
BLOWER/
BLADE ASSEMBLY



(1)
E6004
7" BLOWER
CONE

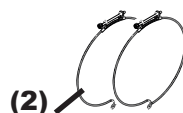

(2)
J0060
6" HOSE
CLAMPS



(2)
J0070
7" HOSE
CLAMPS

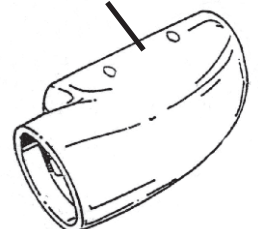

(1)
E2406
BOOT