

# MODEL#: 06621215

MOWER NAME: JOHN DEERE 727

MOWER MODEL: SEE BACK OF PAGE

MOWER DECK SIZE: 54" 7-IRON DECK

VAC NAME: 12 CUBIC FOOT BOX

ENG: 900 SER. BR (9.00 GROSS TORQUE / 205 cc)

NOTE:



FOR YEAR: 2005-2002

REVISED: 5/9/2012

WAS  
066212-ZJR-02

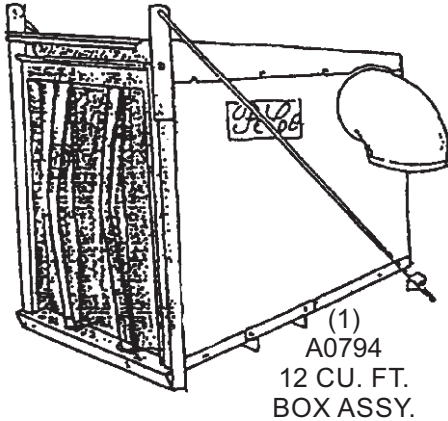

(1)  
V1054  
6" PLASTIC  
INLET

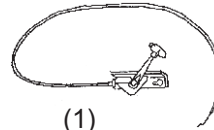

(1)  
A0060  
THROTTLE CABLE  
KIT (70")



(1)  
#HB0151  
HARDWARE  
BAG

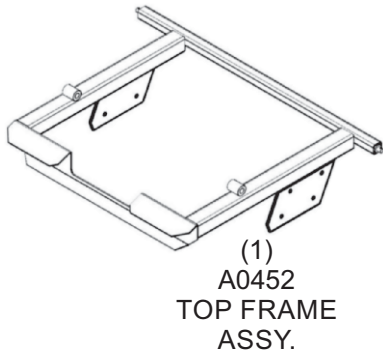
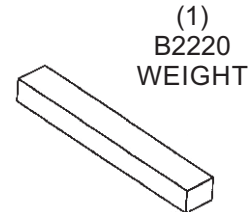
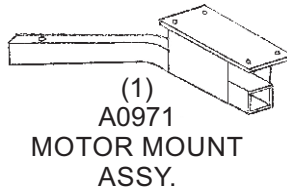

(1)  
6" x 30"  
UPPER  
HOSE

(1)  
8" x 34"  
LOWER  
HOSE

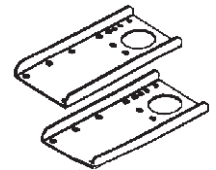

(2)  
B0026  
WEIGHT  
BRACKETS

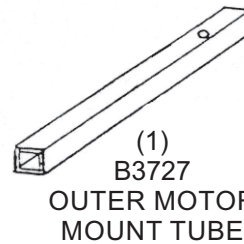

(1)  
B0001  
BOOT PLATE

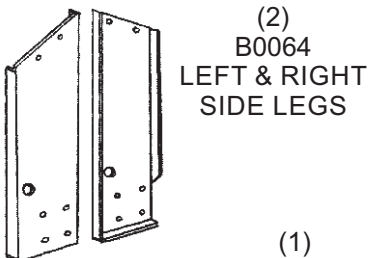

(1)  
ENGINE/  
BLOWER/  
BLADE ASSY.

(1)  
E6009  
8" BLOWER  
CONE

(2)  
J0060  
6" Hose  
Clamps

(2)  
J0080  
8" Hose  
Clamps

(1)  
E1113  
BOOT

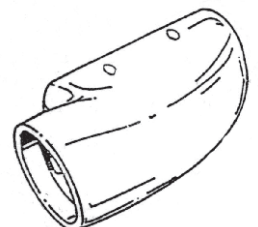
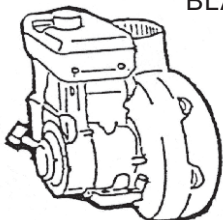

2004

727A

2003

727

2002

727 Z-TRAK-54-DEC

2001