

MODEL#: 06621213

MOWER NAME: JOHN DEERE 717

MOWER MODEL: SEE BACK OF PAGE

MOWER DECK SIZE: 48" 7-IRON DECK

VAC NAME: 12 CUBIC FOOT BOX

ENG: 900 SER. BR (9.00 GROSS TORQUE / 205 cc)

NOTE:



FOR YEAR: 2005-2002

REVISED: 5/9/2012

WAS
066212-ZJR-02

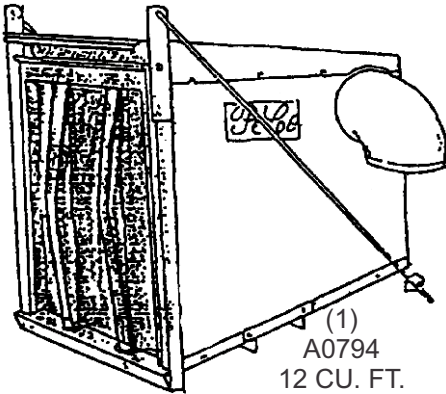

(1)
A0794
12 CU. FT.
BOX ASSY.

(1)
V1054
6" PLASTIC
INLET

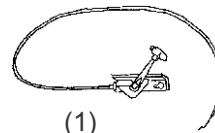

(1)
A0060
THROTTLE CABLE
KIT (70")



(1)
#HB0151
HARDWARE
BAG

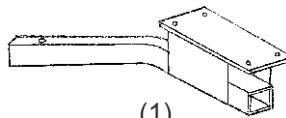

(1)
A0971
MOTOR MOUNT
ASSY.

(1)
B2220
WEIGHT

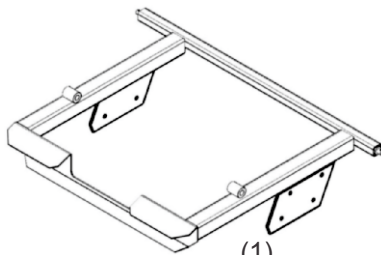
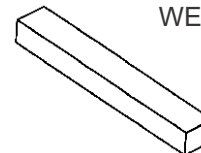

(1)
A0452
TOP FRAME
ASSY.

(1)
6" x 30"
UPPER
HOSE

(1)
8" x 34"
LOWER
HOSE

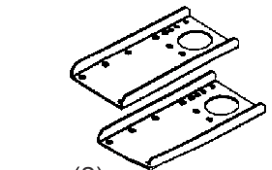

(2)
B0026
WEIGHT
BRACKETS



(1)
E6009
8" BLOWER
CONE

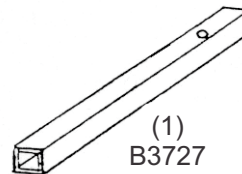

(1)
B3727
OUTER MOTOR
MOUNT TUBE

(1)
B0001
BOOT PLATE

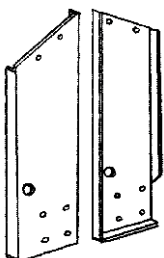

(2)
B0064
LEFT & RIGHT
SIDE LEGS

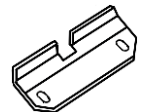

(1)
ENGINE/
BLOWER/
BLADE ASSY.

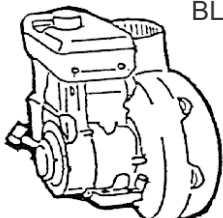

(2)
J6006
7" - 8"
HOSE CLAMPS



(1)
E1039
BOOT

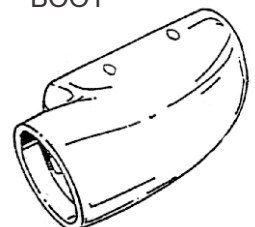

2004

717A

2003

717

2002

717 ZT TRACK 48 DEC

2001