

MODEL#: 37621230

MOWER NAME: SCAG

MOWER MODEL: TURF TIGER

MOWER DECK SIZE: 61", 52" & 48" VELOCITY PLUS

VAC NAME: 12 CUBIC FOOT BOX

6.5 BRIGGS AND STRATTON VANGUARD

BILL OF MATERIAL: BOM0271

NOTE:



FOR YEAR: 2006 - 2005

REVISED: 12/20/11

A0675 UNIT ASSY.

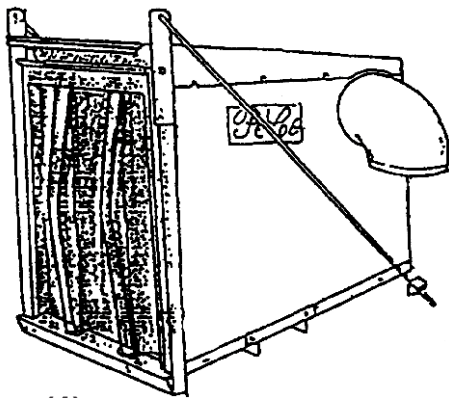

(1)
A0794
12 CU. FT.
BOX ASSY.

(1)
V1054
6" PLASTIC
INLET

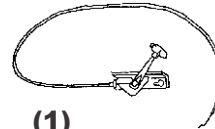

(1)
A0060
70" THROTTLE
KIT FOR (5.5 & 6.5HP)



(4)
J1000
2" - 10"
HOSE CLAMPS



(1)
HB0251
HARDWARE
BAG

(1)
6" x 39"
UPPER
HOSE



(1)
8" x 44"
LOWER
HOSE



(1)
E6009
8" BLOWER
CONE

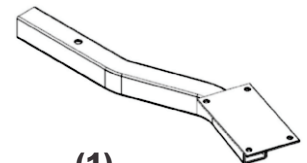

(1)
A0019
ENGINE MOUNT
ARM ASSY.

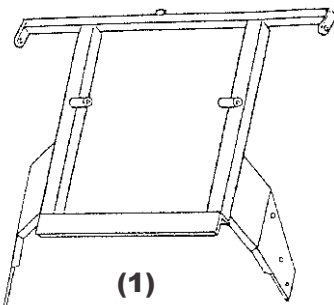

(1)
A0923
MAIN FRAME
ASSY.

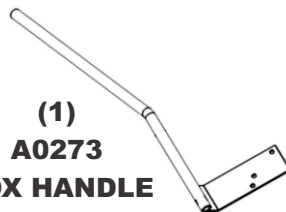

(1)
A0273
BOX HANDLE
ASSY.

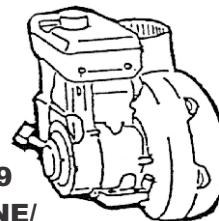

(1)
A639
ENGINE/
BLOWER/
BLADE ASSY.

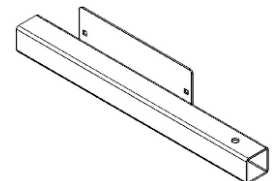

(1)
A0416
OUTER ENGINE
MOUNT ASSY.

A0674 WEIGHT KIT



(1)
HB0138
HARDWARE
BAG

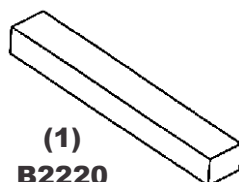

(1)
B2220
WEIGHT

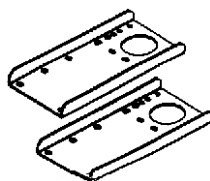

(2)
B0026
WEIGHT
BRACKET

A0664 BOOT KIT



(1)
HB0247
HARDWARE
BAG

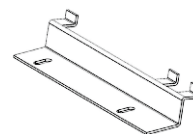

(1)
B0309
BOOT
PLATE

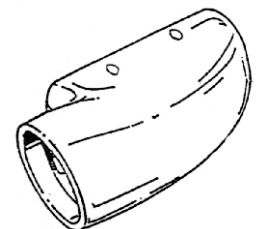

(1)
E0012
BOOT