

MODEL#: 23621218

MOWER NAME: BOB-CAT

MOWER MODEL: ZT-200 SERIES, PREDATOR PRO

MOWER DECK SIZE: 48", 52", & 61" DECK

VAC NAME: 12 CUBIC FOOT BOX



FOR YEAR: 2005 & BELOW

6.5HP BRIGGS AND STRATTON VANGUARD

NOTE: 218 ES HAS A SEPARATE PACK DRAWING

REVISED: 12/19/11

WAS:

236212-ZT200-03

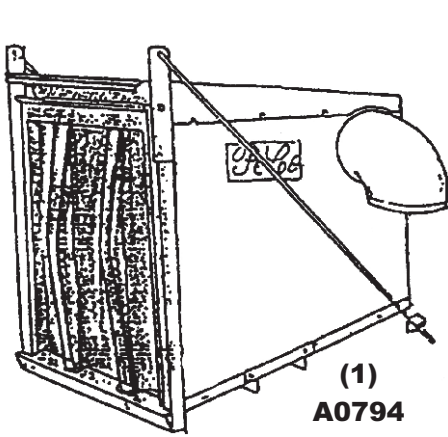

(1)
A0794
12 CU. FT.
BOX ASSY.

(1)
V1054
6"
PLASTIC

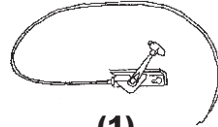

(1)
A0060
THROTTLE CABLE
KIT (70")
FOR (5.5 & 6HP)

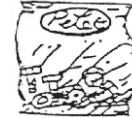

(1)
#HB0118
HARDWARE
E

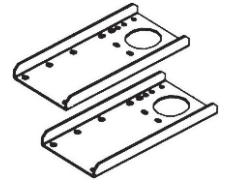

(2)
B0026
WEIGHT
BRACKETS
(WEIGHT KIT
ASSY. # A0275)

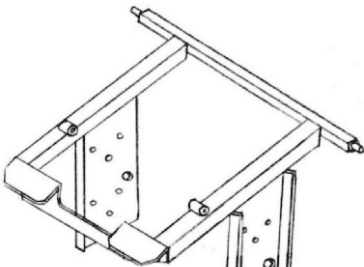

(1)
A0319
MAIN FRAME
ASSY.



(1)
6" x 32"
UPPER
HOSE

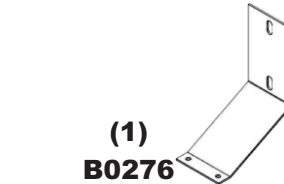

(1)
B0276
AIR CLEANER
MOUNT



(1)
B0275
AIR CLEANER
MOUNT PLATE

(1)
8" x 48"
LOWER
HOSE

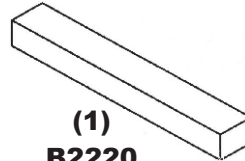

(1)
B2220
WEIGHT
KIT
(WEIGHT KIT
ASSY. # A0275)

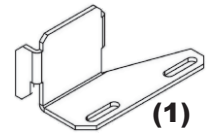

(1)
B0079
BOOT
PLATE



(1)
E6009
8" BLOWER
CONE



(2)
J0060
6" Hose
Clamps

(2)
B0046
LEFT & RIGHT
LOWER MAIN
FRAME

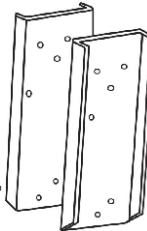

(1)
A0318
MOTOR
MOUNT

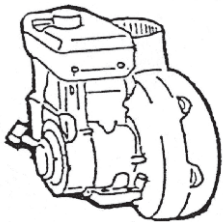

(1)
A639
ENGINE/
BLOWER/
BLADE ASSY.

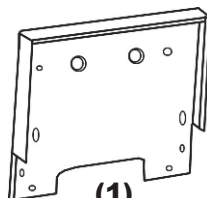

(1)
B0047
REAR
MOUNT



(2)
J0080
8" Hose
Clamps

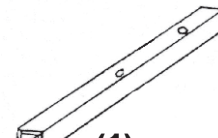

(1)
B1117
OUTER MOTOR
MOUNT TUBE

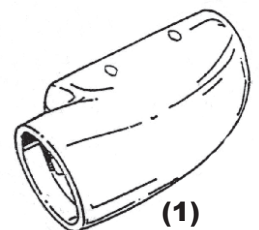

(1)
E1030
BOOT