

MODEL#: 06621241

MOWER NAME: JOHN DEERE

MOWER MODEL: 737 & 757 W/ ROPS

MOWER DECK SIZE: 54"

VAC NAME: 12 CUBIC FOOT BOX

6.5 BRIGGS AND STRATTON VANGUARD

BILL OF MATERIALS: BOM0257



FOR YEAR: 2007 - 2005

REVISED: 12/19/11

A0587 - UNIT ASSEMBLY

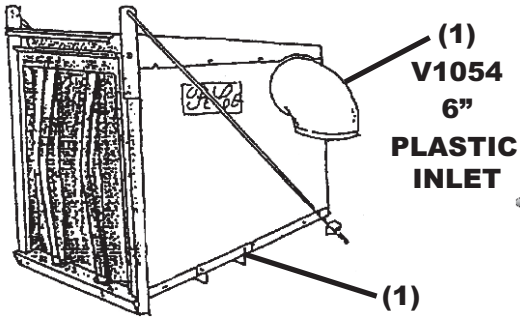

(1)
V1054
6"
PLASTIC
INLET

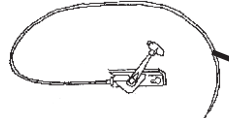

(1)
A0060
70" THROTTLE
KIT (5.5 & 6.5HP)

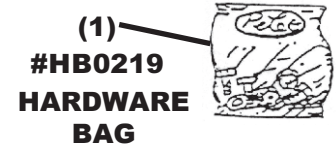

(1)
#HB0219
HARDWARE
BAG

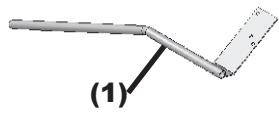

(1)
A0273
BOX
HANDLE



(1)
6" x 38"
UPPER
HOSE



(1)
8" x 44"
LOWER
HOSE

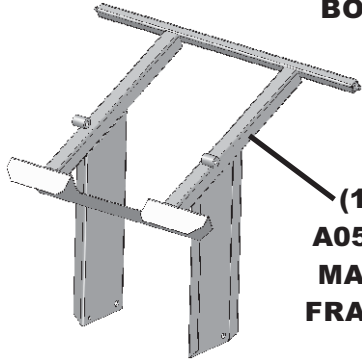

(1)
A0547
MAIN
FRAME

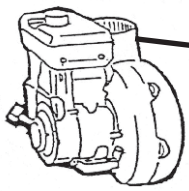

(1)
A639
ENGINE/
BLOWER/
BLADE ASSY.



(1)
E6009
8" BLOWER
CONE

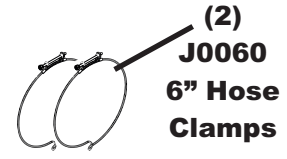

(2)
J0060
6" Hose
Clamps

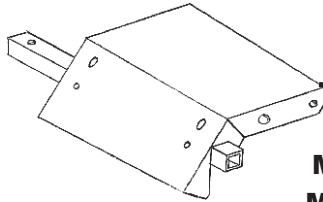

(1)
A0383
MAIN FRAME
MOUNT ASSY.

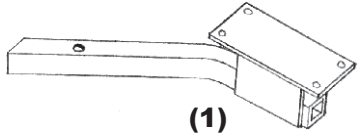

(1)
A0393
MOTOR MOUNT
ARM ASSY.

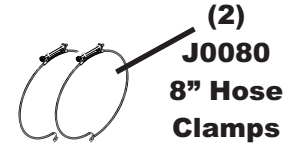

(2)
J0080
8" Hose
Clamps

A0586 - WEIGHT KIT

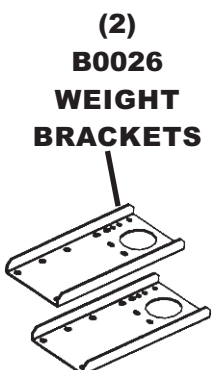

(2)
B0026
WEIGHT
BRACKETS

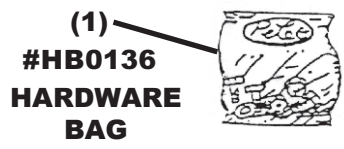

(1)
#HB0136
HARDWARE
BAG

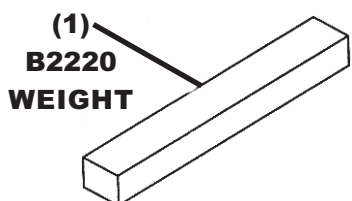

(1)
B2220
WEIGHT

A0552 - 54" BOOT KIT



(1)
#HB0218
HARDWARE
BAG

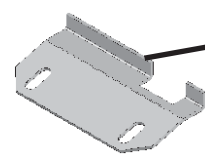

(1)
B0001
BOOT
PLATE

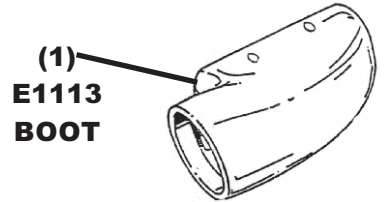

(1)
E1113
BOOT