

# MODEL#: 06031508

MOWER NAME: JOHN DEERE

MOWER MODEL: Z900 SERIES

MOWER DECK SIZE: 60" 7-IRON

VAC NAME: 15 CUBIC FOOT PRO BAGGER

6.5 BRIGGS AND STRATTON VANGUARD

MANUAL: Q0404



FOR YEAR: 2009 - 2011

REVISED: 12/20/11

## A1777 UNIT ASSEMBLY

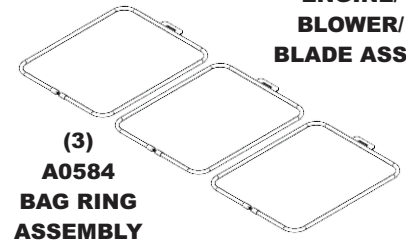
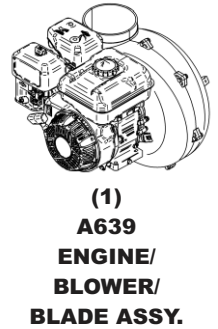
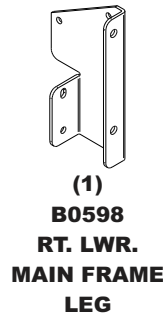
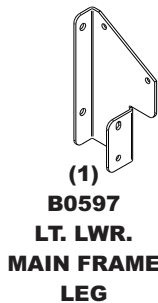
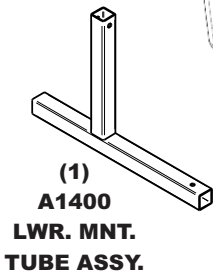
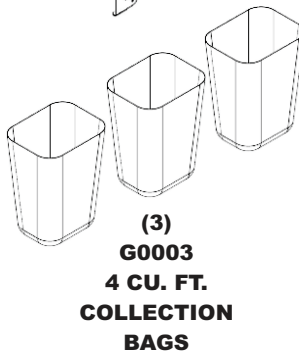
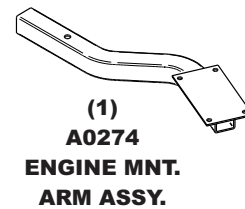
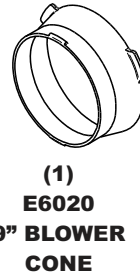
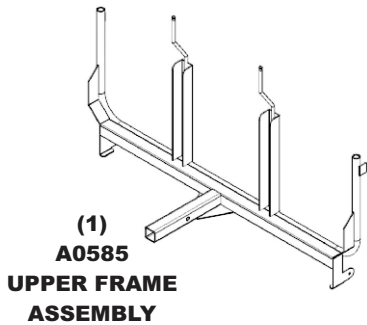
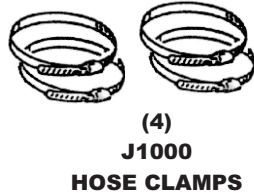
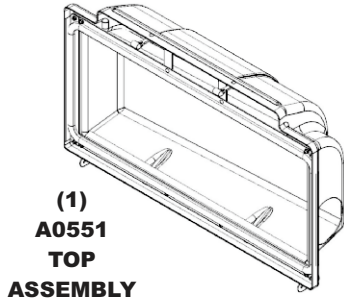

## A1768 - WEIGHT KIT

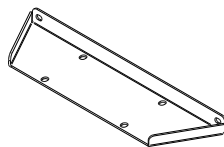

(1)  
B0035  
WEIGHT

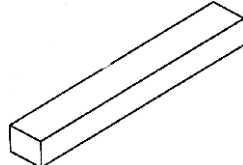

## A1767 - 60" BOOT KIT

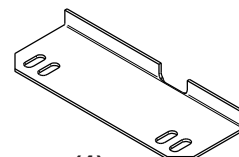

(1)  
E1126  
BOOT

