

MODEL 35621207 - 10

PECO

**PECO OWNERS MANUAL
FOR A EXMARK LAZER EPS UNIT**

(MODEL #LZ26KC604, LZ28KC604, LZ26KC724, LZ28KC724)

PART #: Q0271

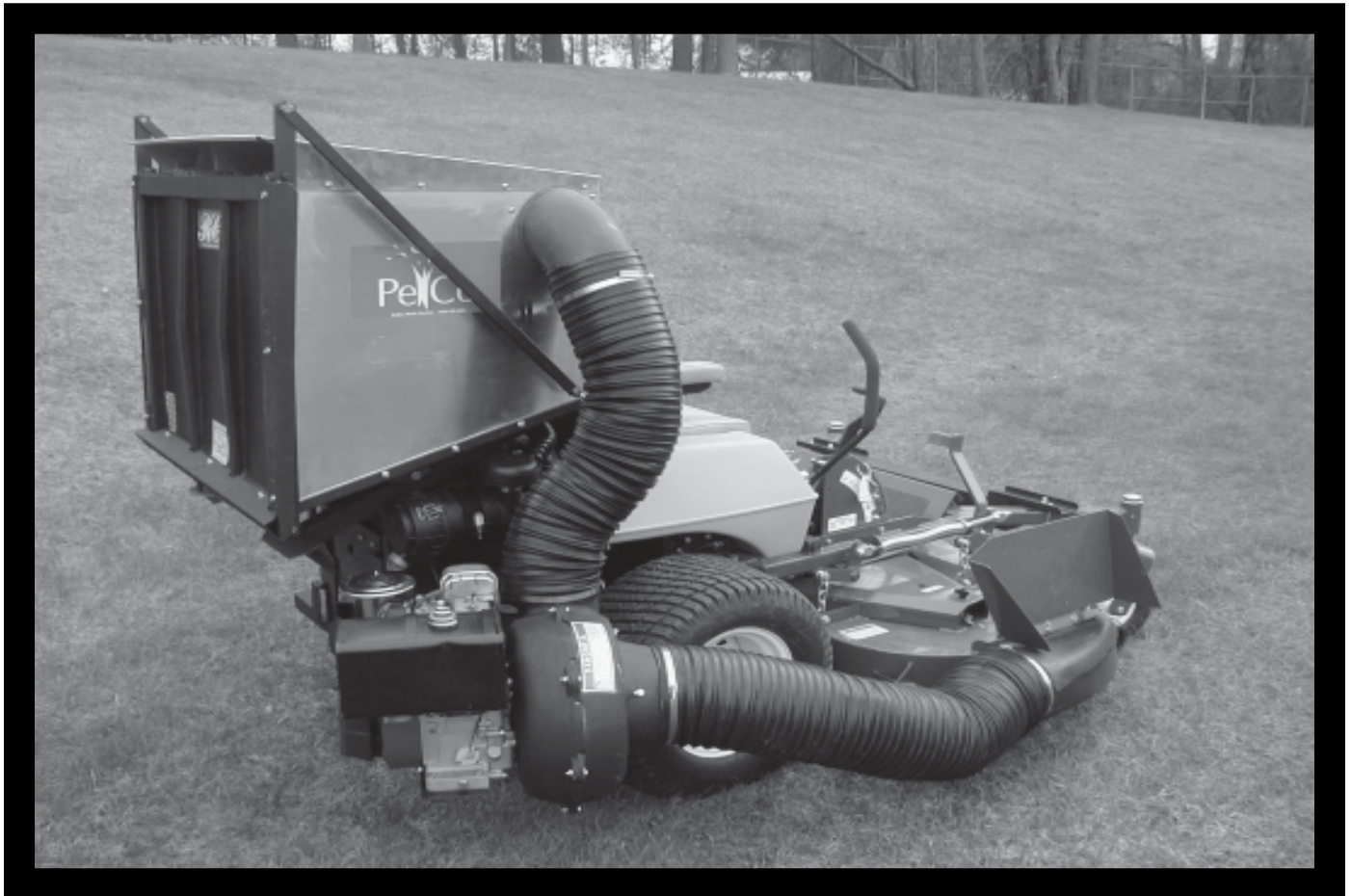

CONGRATULATIONS AND THANK YOU FOR BUYING THIS PECO LAWN VACUUM.

Your new PECO Vac has been engineered and manufactured to PECO's high standards for safety, quality, dependability, and ease of operations.

SAVE THIS MANUAL FOR FUTURE REFERENCE

PeCo Limited Warranty for New Products

A. WHAT IS WARRANTED?

PeCo extends the following warranties to the original purchaser of each new PeCo consumer product subject to the following limitations.

1. PRODUCT WARRANTY.

Any part of any consumer product, which is defective in material or workmanship as delivered to the purchaser will be repaired or replaced, as PeCo elects, without charge for parts or labor, if the defect appears within 12 months from the date of delivery of the product to the original purchaser. **ALL DEFECTIVE PARTS MUST BE RETURNED TO PeCo FOR INSPECTION TO DETERMINE VALIDITY OF WARRANTY CLAIMS.** Freight and mailing charges will be borne by the customer.

2. PARTS REPLACED DURING WARRANTY.

Any new PeCo part which is furnished in performance of this warranty and is defective in material or workmanship as delivered to the purchaser will be repaired or replaced, as PeCo elects, without charge if the defect appears within 90 days from the date of installation of such part or before the expiration of the original warranty period, whichever is later.

B. SECURING WARRANTY ADJUSTMENTS

Damaged or broken parts other than engines or batteries, must be returned to PeCo, Inc., P.O. Box 1197, Arden, NC 28704 before any warranty adjustment can be authorized. At the time of requesting warranty adjustment, the purchaser must present evidence of the date of delivery of the product. The purchaser shall pay any charge for transporting the product to and from Arden, NC.

C. ITEMS NOT COVERED BY PeCo WARRANTY.

Engines and batteries attached to PeCo products are covered under a separate warranty by the respective manufacturer.

D. UNAPPROVED ALTERATION OR MODIFICATION.

All obligations of PeCo, Inc. under this warranty shall be terminated if products are altered or modified in ways not approved by PeCo, Inc.

E. ACCIDENTS AND NORMAL MAINTENANCE.

The warranty covers only defective material and workmanship. It does not cover depreciation or damage caused by normal wear, accident, improper use or abuse of products. The cost of normal maintenance and normal replacement of service items such as belts, cutting blades, hoses, etc., which are not defective shall be paid for by the purchaser.

F. NO REPRESENTATIONS ADDITIONAL WARRANTIES, DISCLAIMER.

Neither PeCo, Inc. nor any company affiliated with it makes any warranties, representations or promises as to the quality of performance of its products other than those set forth herein. Except as described above, PeCo, Inc. makes no other warranties **AND SPECIFICALLY DISCLAIMS ANY AND ALL IMPLIED WARRANTIES OF FITNESS AND MERCHANTABILITY.**

G. ANY MACHINE USED FOR RENTAL OR COMMERCIAL PURPOSES ARE GUARANTEED FOR 45 DAYS FROM DATE OF ORIGINAL SALE ONLY.

H. REMEDIED EXCLUSIVE.

The only remedies the purchaser has in connection with the breach or performance of any warranty on PeCo, Inc. consumer products are set forth above. In no event will PeCo be liable for special incidental or consequential damages.

I. NO SERVICE CENTER WARRANTY.

The selling Service Center makes no warranty on his own on any item warranted by PeCo, Inc. unless he delivers to purchaser a separate written warranty certificate specifically warranting the item. The dealer has no authority to make any representation or promise on behalf of PeCo or to modify the terms of limitations of this warranty in any way.

Outdoor Power Equipment Institute Recommendations

WARNING TO PURCHASERS OF INTERNAL COMBUSTION ENGINE EQUIPPED MACHINERY OR DEVICES IN THE STATE OF CALIFORNIA:

The equipment which you have purchased does not have a spark arrester muffler. If this equipment is to be used on any forest covered and brush covered land or grass covered unimproved land in the state of California, the law requires that a spark arrester muffler be installed and be in effective working order. The spark arrester must be attached to the exhaust system and comply with Section 4442 of the California Public Resources Code.

1. Read the owner's manual carefully and familiarize yourself with the proper use of your attachment. Do not allow anyone who is not acquainted with the Safety Instructions to use your attachment.
2. Know the controls and how to stop quickly. **READ THE OWNER'S MANUAL!**
3. Do not allow children to operate the vehicle. Do not allow adults to operate it without proper instruction.
4. Be especially watchful of children and pets darting into the area while operating.
5. Keep your eyes and mind on your tractor while mowing or operating your attachment. Don't let others distract you.
6. Do not attempt to operate your tractor or mower when not in the driver's seat.
7. Always stop Vac engine when emptying the container.
8. Stop tractor and vac engines and remove spark plug wire before removing or replacing hose, boot, blower cone or performing any maintenance.
9. Mow up and down the face of slopes (not steeper than 10 degrees); never across the face of the slope.
10. It is recommended that the container be kept only half full when negotiating any slopes. Start mowing on slopes when the container is empty.
11. Inspect your lawn and remove any foreign objects before mowing. Never deliberately run mower across any foreign object.
12. Wear ear protection if noise level is offensive.

WARNING!

NEVER operate the mower unless the discharge guard and either the deflector assembly or the vacuum collector adapter are fastened securely in place.

WARNING!

To avoid serious injury, perform maintenance on the vacuum collector **ONLY AFTER STOPPING THE TRACTOR ENGINE AND WAITING FOR ALL MOVING PARTS TO COME TO A COMPLETE STOP.** Set the parking brake. Always remove the ignition key before beginning the maintenance

WARNING!

Do not work around the mower deck boot or the blower area until you are certain that the mower blades and the blower fan have stopped rotating.

WARNING!

For your personal safety, **ALWAYS** mow **UP** and **DOWN** the face of slopes and **NEVER** across the face. **NEVER** attempt to mow excessively steep slopes and use caution when turning on any slope.

STEP 1:

Remove the mower's air intake (A) and the two side rails. Slide the main frame (B) over the mower's muffler as shown. Place the plastic hose (C) (PN#F0035) provided in the hardware bag on as shown. Secure the air intake bracket to the main frame (B) using (2) 3/8"-16 x 3" HEX BOLTS (PN#K1198) and (2) 3/8"-16 flange nuts (PN#K1215). Drop the (2) rear support brackets (D) in underneath the main frame, and (1) mount bracket spacer underneath each of the support brackets. Secure the support brackets (D) using (4) 3/8"-16 x 1-1/2" hex bolts (PN#K3135) and (4) 3/8"-16 flange nuts. Slide the mower's side rails back into place and secure using (4) 3/8"-16 x 1" carriage bolts (PN#K1191) and (4) 3/8"-16 flange nuts. Finish securing the main frame assembly (B) by using (4) 3/8"-16 x 1" carriage bolts (PN#K1191) and (4) 3/8"-16 flange nuts (PN#K1215).

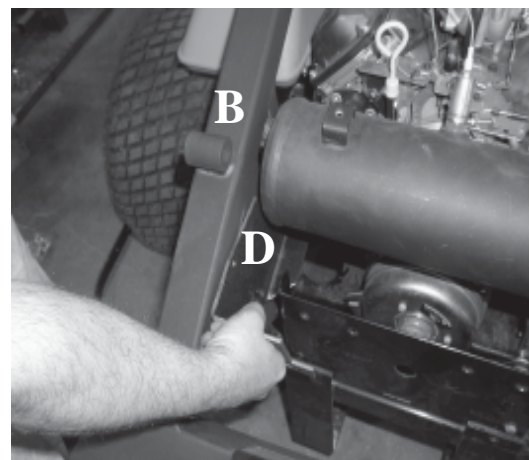
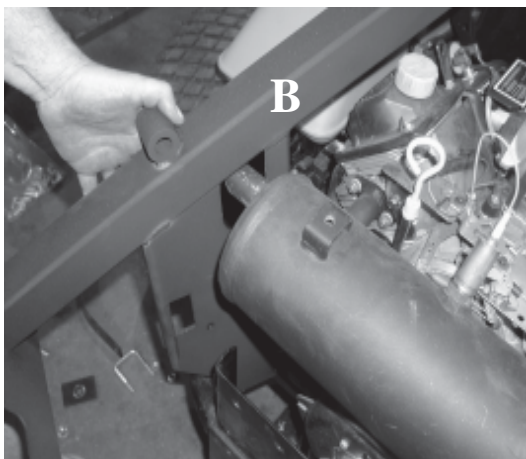
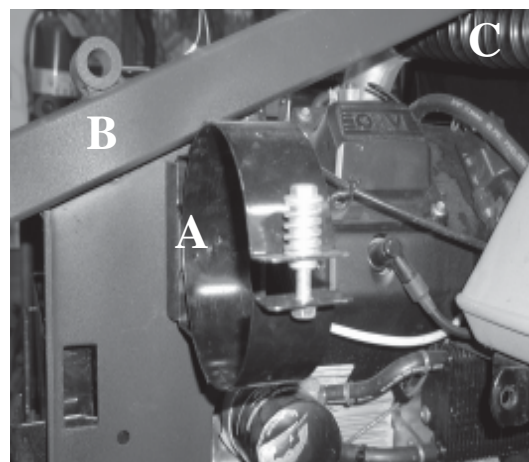
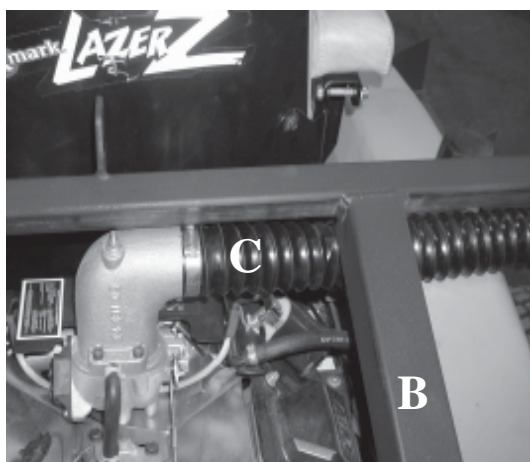

STEP 2:

Place the outer motor mount assembly (A) as shown in the picture. Secure the outer motor assembly using (2) 3/8"-16 u-bolts (PN#K1432) and (4) 3/8"-16 flange nuts (PN#K1215).

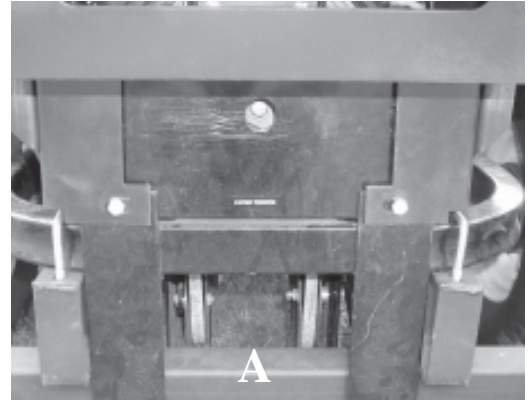

STEP 3:

Slide the motor mount arm assembly (A) in to the outer motor mount assembly (B). Secure using (1) detent pin (PN#J0248). Place the engine on top of the motor mount arm assembly (A). Secure using (4) 5/16"-18 x 1-3/4" hex bolts (PN#K1157) and (4) 5/16"-18 flange nuts (PN#K1178).

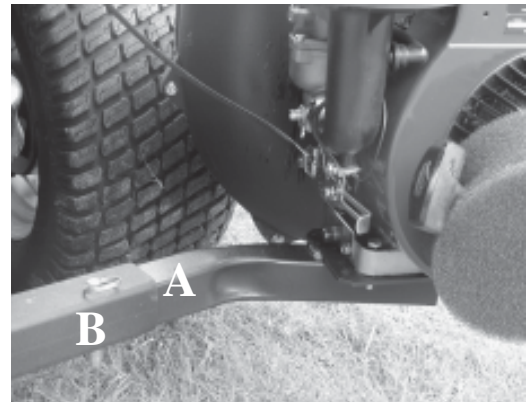

STEP 4:

Secure the boot (A) to the boot plate (B) by using (2) 3/8"-16 x 2" carriage bolts (PN#K1184) and (2) 3/8"-16 flange nuts. Slide and hook the boot & boot plate to the deck

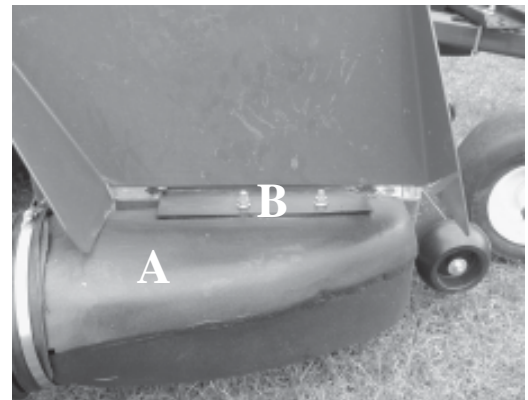

STEP 5:

Place the weight assembly (A) as shown in the picture. Secure the weight assembly (A) using (2) 3/8"-16 u-bolts (PN#K1423) and (4) 3/8"-16 flange nuts (PN#K1215).

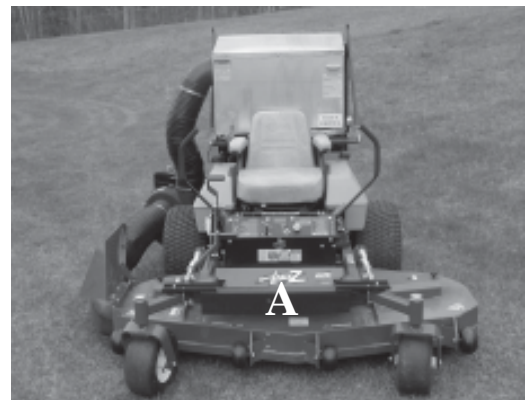

PARTS LIST



REF. NO.	PART NO.	DESCRIPTION	QTY.
01	E1030	BOOT (60" DECK)	1
	E1112	BOOT (72" DECKS)	1
02	J6006	7"-8" HOSE CLAMPS	2
03	*****	8" x 45" LOWER HOSE	1
04	E6009	8" BLOWER CONE	1
05	*****	ENGINE/BLOWER/BLADE ASSEMBLY	1
	E4052A	BLOWER HOUSING	
	D1016	6HP KOHLER ENGINE	
	A0914	4 BLADE IMPELLER W/ S4302 BUSHING W/ 1" SHAFT	
06	J6011	5"-6" HOSE CLAMPS (60" DECK)	2
	J6006	7"-8" HOSE CLAMPS (72" DECK)	2
07	*****	6" x 39" UPPER HOSE (60" DECK)	1
	*****	7" x 40" UPPER HOSE (72" DECK)	1
08	#HB0030	HARDWARE BAG (60" DECK)	1
	#HB0031	HARDWARE BAG (72" DECK)	1
09	A0105	MAIN FRAME ASSEMBLY	1
10	A0903	MOTOR MOUNT ASSEMBLY	1
11	A0110	OUTER MOTOR MOUNT ASSEMBLY	1
12	B1417	LEFT & RIGHT LOWER FRAME BRACES	2
13	B1373	MOUNTING BRACKETS	2
14	B1425	AIR CLEANER BRACKET	1
15	B1717	BOOT PLATE (60" DECK)	1
16	B1509	BOOT PLATE (72" DECK)	1
17	A0294	THROTTLE KIT	1
18	A0907	WEIGHT ASSEMBLY	1

PARTS DIAGRAM

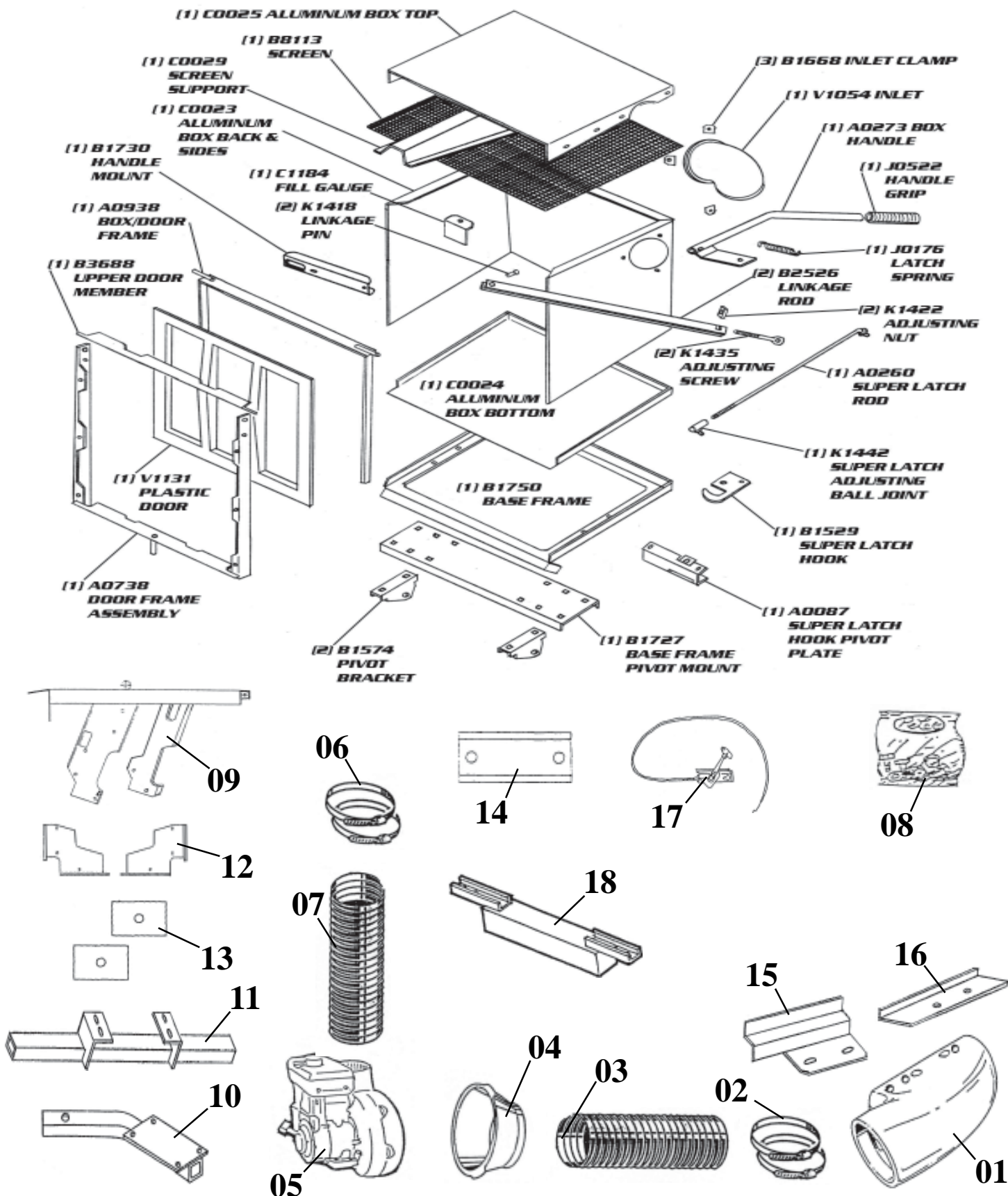

STEP 6:

The ears of the cone (A) should fit underneath the two threaded bosses on the blowerface (B). Secure with (2) 5/16"-18 x 2" hex bolts (PN#K1159).

TIGHTEN ALL NUTS AND BOLTS!

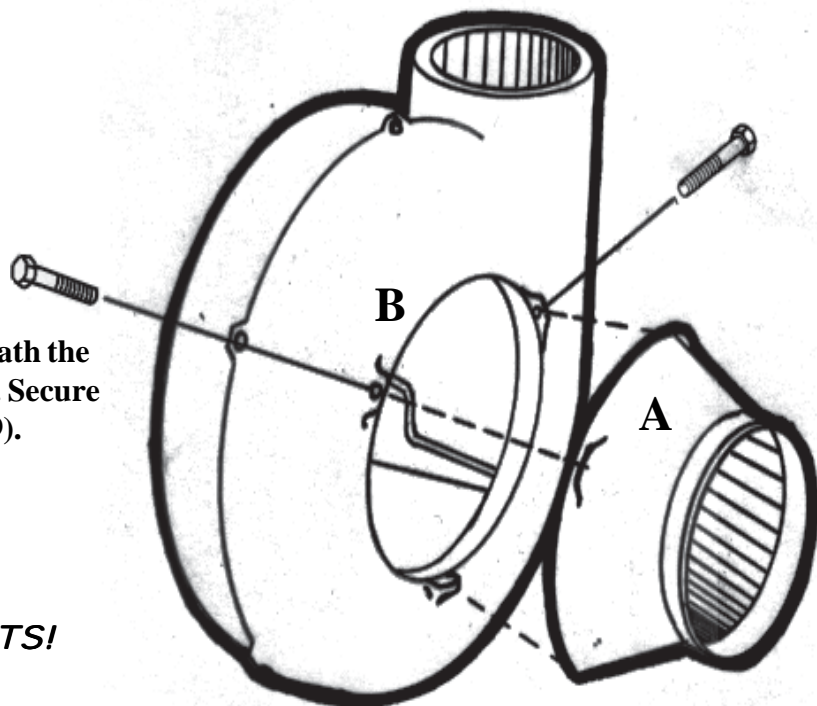

IMPELLER BLADE REPLACEMENT

TO REMOVE: First remove hex bolts from hub, then screw the bolts into threaded holes to remove old blade. (This will push impeller off the hub.) If the impeller will not move, hit the base of the impeller between each vein with a hammer, then try again.

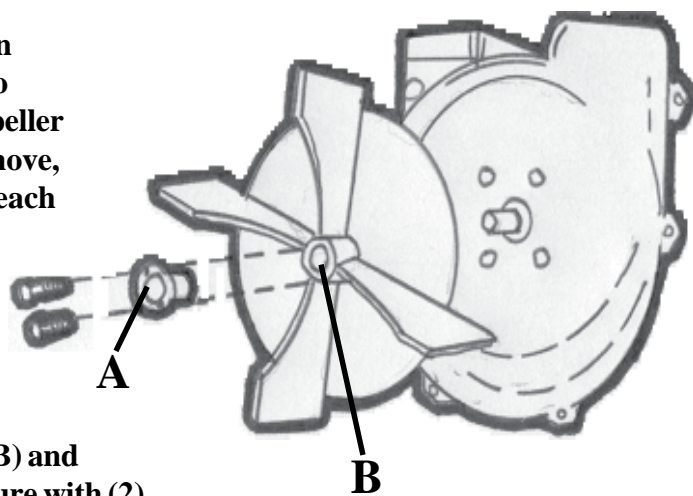

TO REPLACE: Place tapered bushing (A) into hub (B) and align non-threaded holes in hub. Secure with (2) 1/4" x 1" hex bolts. Torque to 15 ft. lbs.

STEP 7:

Place the hose clamps over each end of the 6" hose (A). Attach one end of the hose onto the blower housing (B). Attach the free end of the hose over the inlet (C). Tighten the hose clamps.

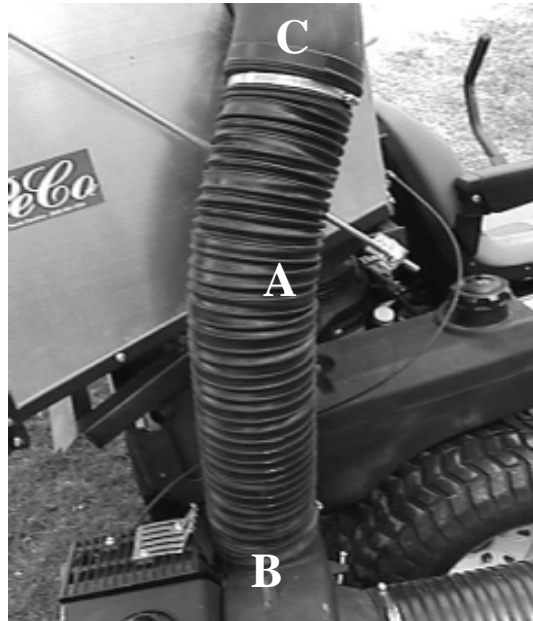

STEP 8:

Place the hose clamps over each end of the lower hose (D). Attach one end of the hose over the blower cone (E). Slide the free end of the hose over the boot (F) and tighten the hose clamps.



TIGHTEN THE HOSE CLAMPS BEFORE EACH USE!

Your PeCO Lawn Vac was designed and built to provide years of service with only minor care. Certain tasks however must be performed to keep it in good operating condition and to avoid costly repairs. This section describes and provides procedures for the necessary care of the Lawn Vac.

SCHEDULED CARE	CARE REQUIRED
Before Each Use	Check engine oil. Check all hose connections.
After Each Use	Clean Collector Box, hoses and engine of all grass and dirt.
Every 10 Hours	Check to be sure all screws, nuts, bolts, pins, etc. are present and secure.

Storage

Never store your PeCo Lawn Vac with a full or partially filled container; decaying grass and leaves may constitute a fire hazard if left too long. Never leave your vac exposed to the elements. While the metal parts are protected with a quality paint, the engine and other unprotected parts may deteriorate if left exposed to rain or snow.

Emptying The Lawn Vac

When the container becomes full, the blower tone will change. In order to empty the container - Release the back door by moving the dump handle on the left hand side of the container. Release the door, push back on the container and the debris falls out. When empty, pull the box forward; move the dump handle in to properly close the rear door.

Service

PeCo Lawn Vac Owners should record the name and telephone number of their Service Center. Your Service Center will be happy to supply replacement parts, and accessories as well as perform necessary service or repairs to your lawn vac. If for some reason your Service Center is unable to service your lawn vac or supply replacement parts, contact PeCo and include the following information:

Tractor Model: _____	Year of Mfg. _____

Deck Size: _____	
PeCo Vac Model: _____	
Vac Serial Number: _____	
Date of Purchase: ____ / ____ / ____	
Service Center's Name: _____	
Service Center's City: _____ State: _____ Zip: _____	
Service Center's Phone Number: _____	

Diagnostic Procedures

Trouble shooting procedures are provided in the chart below. To use these procedures, first locate the problem below that best describes the trouble you have encountered. Check the possible causes in the list one at a time. Correct any problems that are found and operate the vacuum collector again to verify that you have eliminated the problem.

DO NOT attempt any major repairs without first contacting your dealer.

PROBLEM	CAUSE	SOLUTION
Leaves and Grass not being picked up completely	<ol style="list-style-type: none"> 1. Engine speed too slow 2. Ground speed too fast 3. Hose plugged 	<ol style="list-style-type: none"> A. Run at full throttle. B. Use lower gear. C. Check and tighten all hoses. D. Unplug hose.
Hoses plug easily	<ol style="list-style-type: none"> 1. Grass or leaves too wet 2. Grass too high 3. Container full 4. Grass buildup in boot or under mower deck 	<ol style="list-style-type: none"> A. Wait for drier conditions. B. Reduce ground speed/raise deck. C. Empty container. D. Clean thoroughly.
Vacuum Collector blower vibrates excessively	<ol style="list-style-type: none"> 1. Buildup on blower blades 2. Bent or chipped blade 	<ol style="list-style-type: none"> A. Remove cone and clean blades. B. Contact your dealer or PeCo.
Unit fails to fill box	<ol style="list-style-type: none"> 1. Engine speed too slow. 2. Buildup on inlet or screen 3. Grass is too wet or long 	<ol style="list-style-type: none"> A. Run at full throttle. B. Clean thoroughly. C. Wait for dryer conditions.

The Serial Number Plate is located on the aluminum box near the dump handle.

OUTDOOR POWER EQUIPMENT

Model Number

Serial Number

Arden, North Carolina 28704



**P.O BOX 1197
ARDEN, NORTH CAROLINA 28704
1-800-438-5823 OR (828) 684-1234 FAX-(828) 684-0858
E-MAIL: PECOINC1@BELLSOUTH.NET**