



GRASS COLLECTION SYSTEM

DESIGNED FOR:

**MODEL# 37621219 & 37621230
SCAG TURF TIGER SERIES MOWER**



OPERATOR'S MANUAL

ASSEMBLY ● OPERATION ● MAINTENANCE

PECO GRASS COLLECTION SYSTEM

TABLE OF CONTENTS

SECTION	PAGE	SECTION	PAGE
Safety	2	2-11 Blower Cone Installation	11
Safety Alert Symbols	3	2-12 Impeller Blade Removal/Replacement	11
Warranty	4	2-13 The Length Of Hose Adjustment	12
I INTRODUCTION AND DESCRIPTION	5	2-14 Upper Hose Installation	12
1-1 Introduction	5	2-15 Lower Hose To Blower Cone Installation	12
1-2 Description	5	2-16 Lower Hose To Boot Installation	12
II INSTALLATION FOR USE	5	2-17 Front Weight Installation	12
2-1 Preparation Of Mower	5	2-18 Throttle Cable Installation	13
2-2 Top Main Frame Assembly Installation	5	III OPERATING INSTRUCTIONS	14
2-3 Lift Handle Installation	6	3-1 General Safety	14
2-4 Aluminum Grass Container Installation	6	3-2 Operation & Tips On Mowing	14
2-5 Mechanism Adjustment	6	3-3 Unloading The Collection System	14
2-6 Exhaust Diverter Installation	6	IV MAINTENANCE	14
Exploded Parts Views And Assemblies	7-9	4-1 Maintenance Checklist	14
2-7 Mount Tube Assembly Installation	10	V PARTS AND SERVICE	15
2-8 Engine Mount Arm Installation	10	5-1 Parts And Service Information	15
2-9 Engine/Blower/Blade Assembly Installation	10	Safety Decals	16
2-10 Boot Installation	10	Torque Specifications	17

Safety

1. Read the operator's manual carefully and familiarize yourself with the proper use of your attachment. Do not allow anyone who is not acquainted with the Safety Instructions to use your attachment.
2. Know the controls and how to stop quickly. **READ THE OPERATOR'S MANUAL!**
3. Do not allow children to operate the vehicle. Do not allow adults to operate it without proper instruction.
4. Be especially watchful of children and pets darting into the area while operating.
5. Keep your eyes and mind on your unit while mowing or operating your attachment. Don't let others distract you.
6. Do not attempt to operate your unit or mower when not in the driver's seat.
7. Always stop unit when emptying the container.
8. Stop unit, shut off deck attachment, set parking brake, shut off mower engine and remove spark plug wire before removing clogs, removing or replacing hose, boot, blower cone, or performing any maintenance.
9. Mow across the face of slopes (not steeper than 10 degrees); never up and down the face of the slope.
10. It is recommended that the container be kept only half full when negotiating any slopes. Start mowing on slopes when the container is empty.
11. Inspect your lawn and remove any foreign objects before mowing. Never deliberately run the mower across any foreign object.
12. Wear ear protection if the noise level is offensive.
13. Wear eye protection to prevent debris from damaging your eyes.

SAFETY

WARNING! **NEVER** operate the unit unless the discharge guard and either the deflector assembly or the vacuum collector adapter are fastened securely in place.

WARNING! Do not work around the mower deck boot or the blower area until you are certain that the mower blades and the blower impeller have stopped rotating.

WARNING! To avoid serious injury, perform maintenance on the vacuum collector; **ONLY AFTER STOPPING THE MOWER'S ENGINE AND WAITING FOR ALL MOVING PARTS TO COME TO A COMPLETE STOP.** Set the parking brake. Always remove the ignition key before beginning maintenance.

WARNING! For your own personal safety, **ALWAYS** mow **ACROSS** the face of slopes and **NEVER UP and DOWN** the face. **NEVER** attempt to mow excessively steep slopes, and use caution when turning on any slope.

Safety Alert Symbol



This Safety Alert Symbol means: **“ATTENTION! BECOME ALERT! YOUR SAFETY IS INVOLVED!”**

This symbol is used to call attention to safety precautions that should be followed by the operator to avoid accidents. When you see this symbol, carefully read the message that follows and heed its advice. Failure to comply with safety precautions could result in death or serious bodily injury.

Safety Signs

The signal words **DANGER**, **WARNING**, and **CAUTION** are used on the equipment safety signs. These words are intended to alert the viewer to the existence and the degree of hazard seriousness.



White letters on **RED**

This signal word indicates a potentially hazardous situation which, if not avoided, will result in death or serious injury.



Black letters on **ORANGE**

This signal word indicates a potentially hazardous situation which, if not avoided, could result in death or serious injury.

It may also be used to alert against unsafe practices.



Black letters on **YELLOW**

This signal word indicates a potentially hazardous situation exist which, if not avoided, will result in minor or moderate injury.

It may also be used to alert against unsafe practices.

PECO LIMITED WARRANTY FOR NEW PRODUCTS

A. WHAT IS WARRANTED?

PECO extends the following warranties to the original purchaser of each new PECO consumer product subject to the following limitations:

- 1. PRODUCT WARRANTY:** Any part of any consumer product, which is defective in material or workmanship as delivered to the purchaser will be repaired or replaced, as PECO elects, without charge for parts or labor, if the defect appears within 12 months from the date of delivery of the product to the original purchaser. **ALL DEFECTIVE PARTS MUST BE RETURNED TO PECO FOR INSPECTION TO DETERMINE VALIDITY OF WARRANTY CLAIMS.** Freight and mailing will be borne by the customer.
- 2. PARTS REPLACED DURING WARRANTY:** Any new PECO part which is furnished in performance of this warranty and is defective in material or workmanship as delivered to the purchaser will be repaired or replaced, as PECO elects, without charge if the defect appears within 90 days from the date of installation of such part or before the expiration of the original warranty period, whichever is later.

B. SECURING WARRANTY ADJUSTMENTS.

Call PECO for Return Authorization. Damaged or broken parts, other than engines or batteries, must be returned to PECO Inc., 100 Airport Road, Arden, NC 28704 before any warranty adjustment can be authorized. At the time of requesting warranty adjustment, the purchaser must present evidence for date of delivery of the product. The purchaser shall pay any charge for the product to and from Arden, NC.

C. ITEMS NOT COVERED BY PECO WARRANTY.

Engines and batteries attached to PECO products are covered under a separate warranty by the respective manufacturer.

D. UNAPPROVED ALTERATION OR MODIFICATION.

All obligations of PECO Inc., under this warranty, shall be terminated if products are altered or modified in ways not approved by PECO Inc..

E. ACCIDENTS AND NORMAL MAINTENANCE.

The warranty covers only defective material and workmanship. It does not cover depreciation or damage caused by normal wear, accident, improper use or abuse of products. The cost of normal maintenance and normal replacement of service items such as belts, cutting blades, hoses, etc., which are not defective shall be paid for by the purchaser.

F. NO REPRESENTATIONS ADDITIONAL WARRANTIES, DISCLAIMER.

Neither PECO Inc. nor any company affiliated with it makes any warranties, representations or promises as to the quality of performance of its products other than those set forth herein. Except as described above, PECO Inc. makes no other warranties **AND SPECIFICALLY DISCLAIMS ANY AND ALL IMPLIED WARRANTIES OF FITNESS AND MERCHANTABILITY.**

G. ANY MACHINE USED FOR RENTAL PURPOSES ARE GUARANTEED FOR 45 DAYS FROM DATE OF ORIGINAL SALE ONLY.

H. REMEDIED EXCLUSIVE.

The only remedies the purchaser has in connection with the breach or performance of any warranty on PECO Inc. consumer products are set forth above. In no event will PECO be liable for special incidental or consequential damages.

1. NO SERVICE CENTER WARRANTY.

The selling Service Center makes no warranty on his own on any item warranted by PECO Inc. unless he delivers to purchaser a separate written warranty certificate specifically warranting the item. The dealer has no authority to make any representation or promise on behalf of PECO or to modify the terms of this warranty in any way.

SECTION I

INTRODUCTION AND DESCRIPTION

1-1 Introduction

We are pleased to have you as a PECO customer. Your collection system has been designed to give you a low maintenance, simple, and effective way to collect the grass clippings from your mower. This manual is provided to give you the necessary instructions to properly mount and operate the collection system on your mower. Please read this manual thoroughly. Understand what each control is for and how to use it. Observe all safety decal precautions on the machine and noted throughout the manual.

NOTE: all references made to right, left, front, rear, top or bottom are as viewed from the normal operator's position on the mower.

1-2 Description

The collection system is designed for turf maintenance where there is a need to collect the grass clippings as the mower cuts the turf. It is also good for picking up leaves and twigs in pre-season and post-season clean-up.

The engine/blower/blade assembly, is mounted on the right side of the unit. The blower draws grass clippings from the discharge area of the cutter deck up to the aluminum container mounted over the rear portion of the frame. The operator can engage the engine/blower/blade assembly by starting the engine. Once the container is full of clippings, the operator can easily push and raise the lift handle, releasing the container's rear door and the container will pivot towards the ground.

Section II

INSTALLATION FOR USE

2-1 Preparation Of Mower

Carefully dismantle wooden shipping crate from around the components. Cut retaining straps and separate the parts. The collection system will have various parts located inside. Remove and sort all parts for easy identification.

NOTE: before each step of assembly it will help to study the exploded drawings on pages 7, 8 and 9.

Note: If equipped with a Donaldson air cleaner, unit must be rotated to make clearance for top main frame assembly.

To rotate Donaldson air cleaner, loosen bolt on air cleaner bracket, rotate air cleaner forward as needed for clearance as shown in Figure 2-1, and tighten.

Figure 2-1. Loosen Bolt To Rotate Air Cleaner

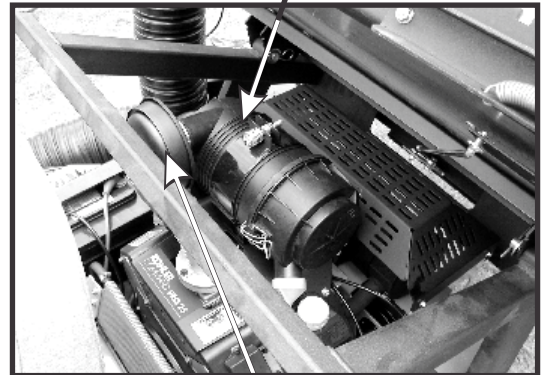

Donaldson Air Cleaner Rotated To Forward Position

2-2 Top Main Frame Assembly Installaton

Place the main frame assembly P#(A0923) onto the rear of the mower and fasten by using (3) 3/8"-16 x 1" HHCS P#(K1191) and (3) 3/8"-16 flange nuts P#(K1215) per side. See Figure 2-2 for details.

Figure 2-2. Main Frame Assembly



(3) 3/8"-16 x 1" HHCS
(3) 3/8"-16 Flange Nuts
Per Leg.

2-3 Lift Handle Installation

The various parts of the handle assembly P#(A0273) must be attached to the container frame. Page 7 shows the orientation and location of the components. Slide the lift handle into the slot in the handle mount bracket P#(B1730) on the grass container. It may be necessary to remove the handle grip P#(J0522) to allow the handle to fit through the slot.

Before attaching the handle, hook one end of the spring P#(J0176) into the hole on the underside of the handle. Hook the other end of the spring into the open hole in the handle mount bracket. Fasten the handle to the grass container frame by using (1) 3/8"-16 x 2" HHCS P#(K1208) and (2) 3/8"-16 flange nuts P#(K1215). At this point the handle can pivot back and forth in the slot of the handle mount bracket. With the handle in place, fasten the ball joint P#(K1442) to the end of the latch rod P#(A0260) (Page 7). Tighten to approximately half way down the threads of the latch rod. Slide the ball joint into the hole on the latch hook P#(B1529). Use (1) 5/16"-24 hex nut P#(K1444) and (1) 5/16" lock washer P#(K0043) to fasten the ball joint to the latch hook. Attach the opposite end of the latch rod into the handle. Fasten the rod to the handle by using (1) 3/32" x 3/4" cotter pin P#(K0094). Adjust the rod to allow the hook to close the box door completely.

Refer to pages 7 and 8 for exploded parts drawings and photographs of the complete assembly.

2-4 Aluminum Grass Container Installation

NOTE: It is recommended that (3) people assist in mounting the container.

With three people available, two can lower the container onto the frame while the third person inserts the pivot pins P#(K0172) through the holes. Insert the pins from the outside to the inside. Secure with (1) 5/8" washer P#(K0058) and (1) 5/32" x 2-5/8" hair pin clip P#(K0088) per pivot pin (Figure 2-4).

Reattach the bottom ends of the door opening linkages to the main frame by using (1) Rue-Ring cotter pin P#(K1437) per side.

To test the functionality of the dump mechanism, pull the lift handle away from the unit, and lift upward (Page 7). The door of the container should open and the box should pivot clockwise towards the ground.

Figure 2-4.

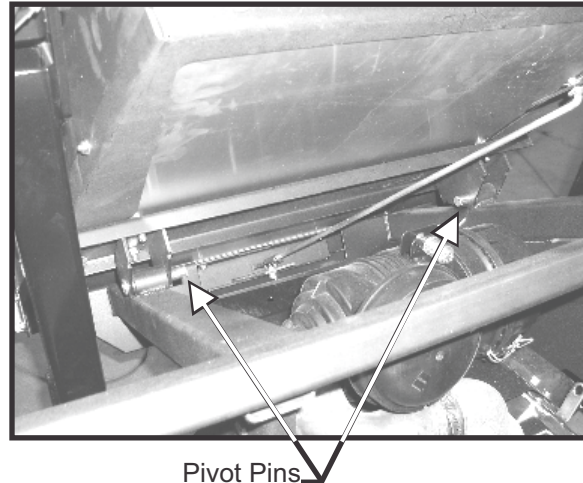

2-5 Dump Mechanism Adjustment

The linkage may be adjusted in two places, at the adjusting screw P#(K1435) and the latch assembly items. See page 7 for visual clarification. To change the door closure tightness, screw the adjusting screw in or out. To adjust the latch, change the length of the latch rod by screwing the latch adjusting ball joint in or out. The latch hook pivot should be in the middle of the slot in the latch hook pivot plate. Slide the pivot back or forth and then re-tighten.

2-6 Exhaust Diverter installation

Mount the exhaust diverter P#(J0250) to the muffler pipe using the exhaust diverter clamp kit P#(X1046) as shown in Figure 2-6.

Figure 2-6.

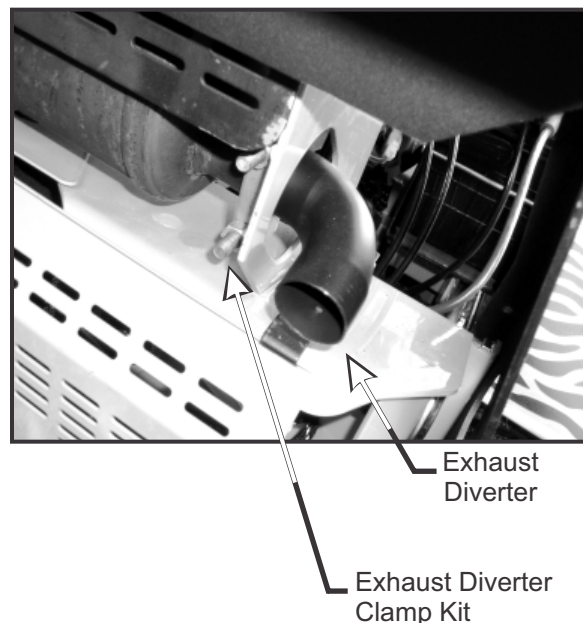

Lift Handle Assembly

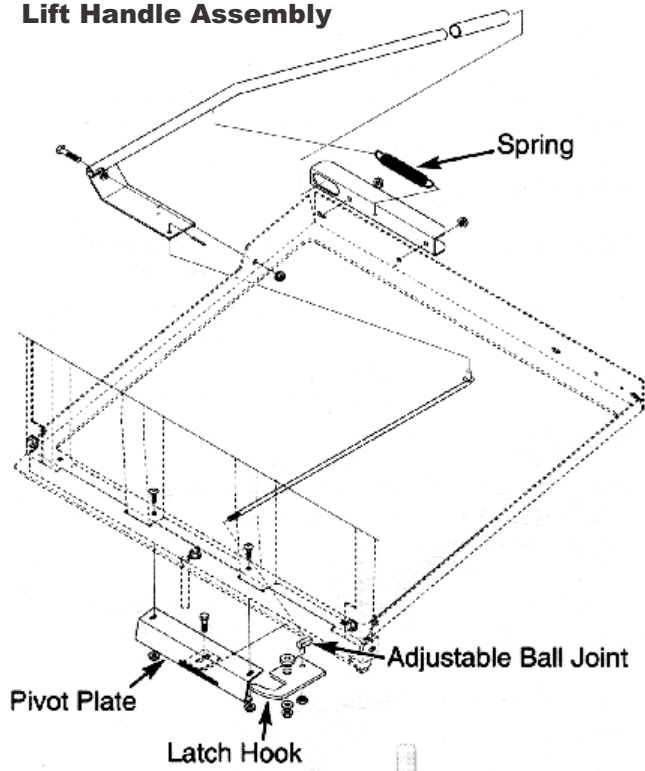

Aluminum Grass Container With Handle Attached



Latch Hook Mechanism Assembly



Aluminum Grass Container Assembly

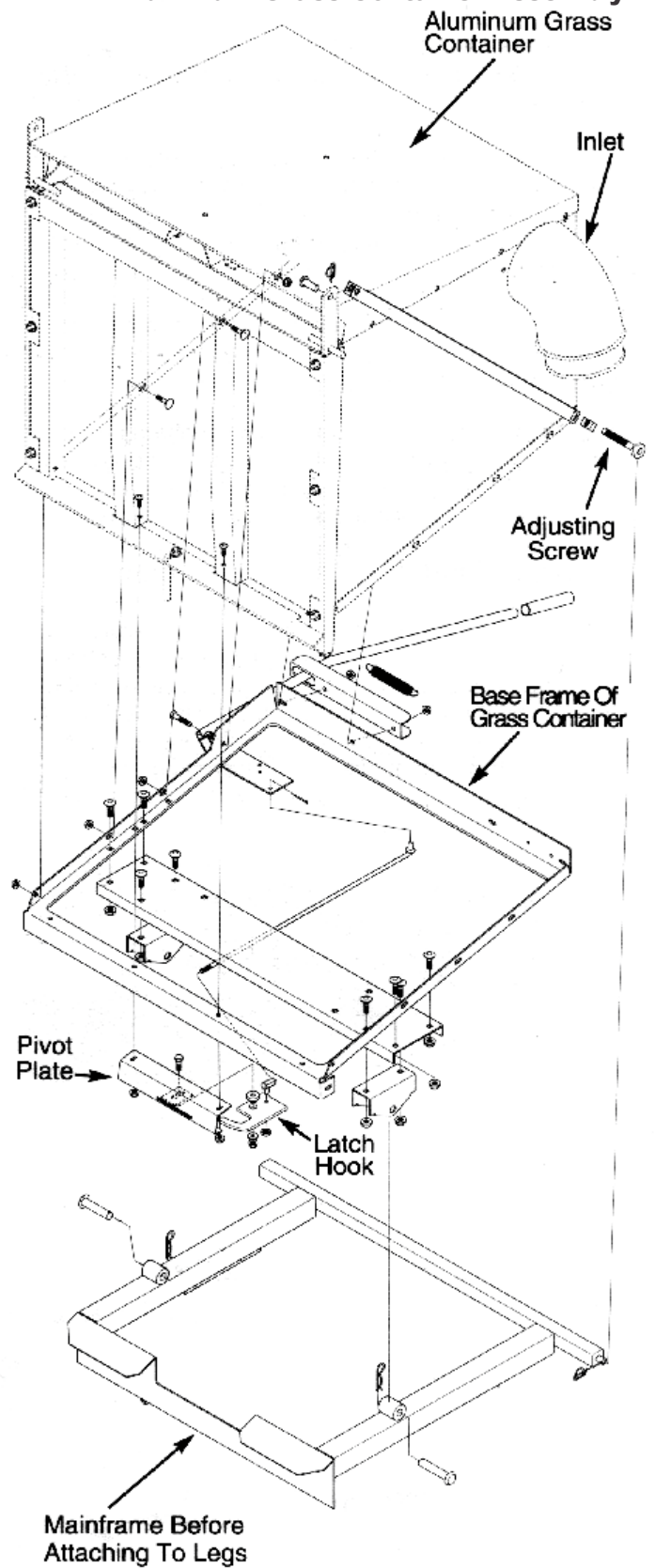

**Aluminum Grass
Container
Exploded View**

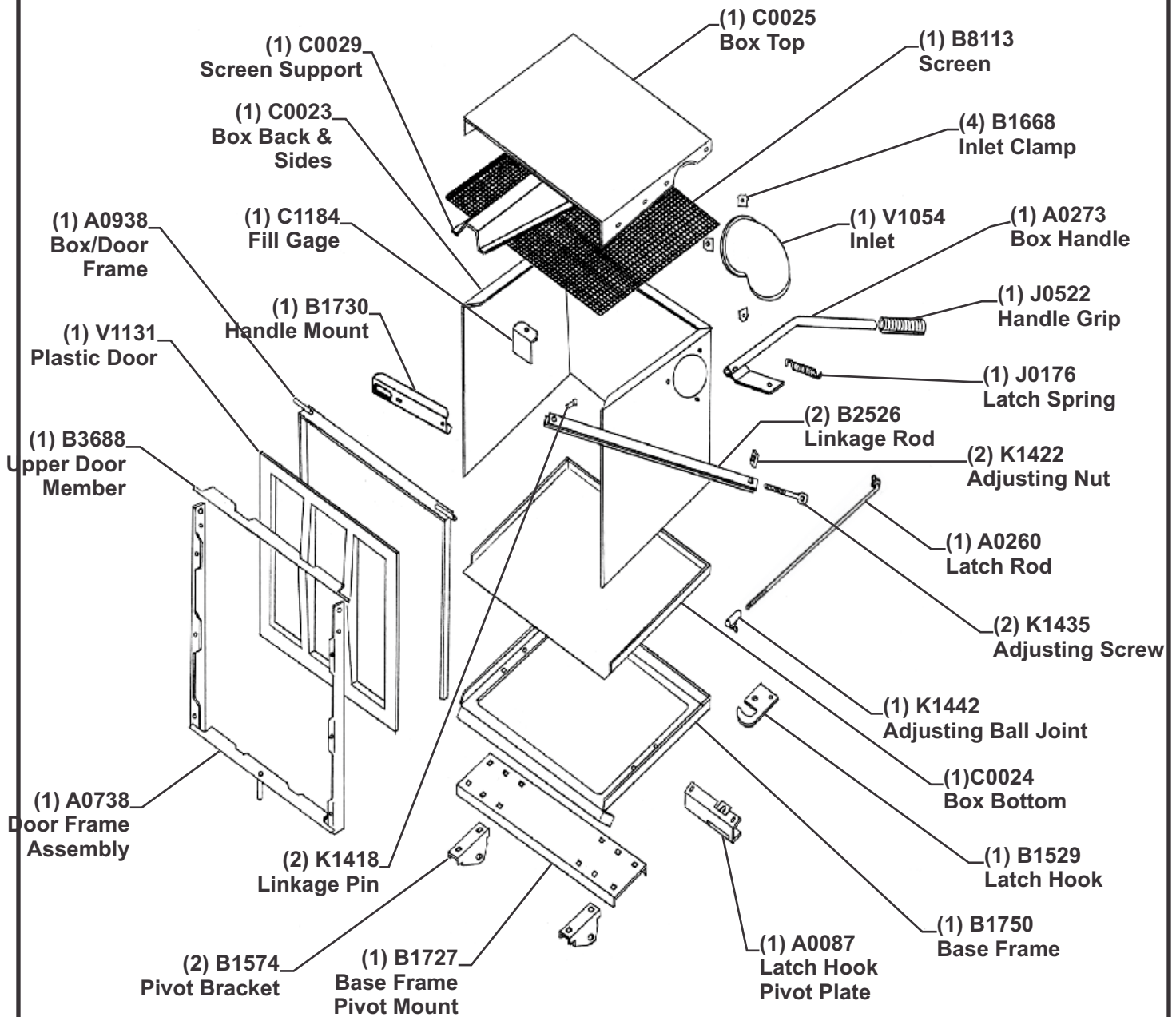

MODEL#: 37621219

MOWER NAME: SCAG

MOWER MODEL: TURF TIGER

MOWER DECK SIZE: 61", 52" & 48" VELOCITY PLUS

VAC NAME: 12 CUBIC FOOT BOX

ENG: 900 SER. BR (9.00 GROSS TORQUE / 205 cc)

BILL OF MATERIAL: BOM0271

NOTE:



FOR YEAR: 2006 - 2005

REVISED: 5/9/2012

A0675 UNIT ASSY.

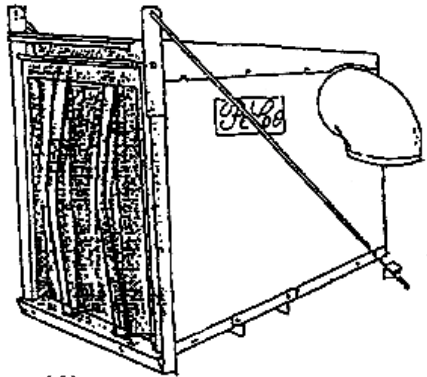

(1)
A0794
12 CU. FT.
BOX ASSY.

(1)
V1054
5" PLASTIC
INLET

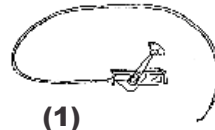

(1)
A0060
LONG THROTTLE KIT
FOR (900 SERIES)



(2)
J6006
7" - 8"
HOSE
CLAMPS



(1)
HB0251
HARDWARE
BAG

(1)
6" x 39"
UPPER
HOSE



(1)
8" x 44"
LOWER
HOSE



(1)
E6009
8" BLOWER
CONE

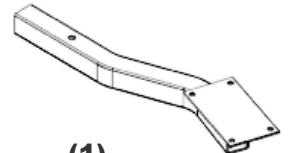

(1)
A0019
ENGINE MOUNT
ARM ASSY.

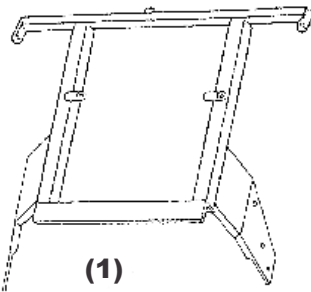

(1)
A0923
MAIN FRAME
ASSY.



(1)
A0273
BOX HANDLE
ASSY.

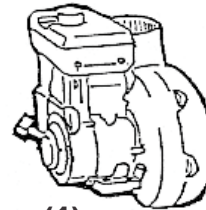

(1)
ENGINE/
BLOWER/
BLADE ASSY.

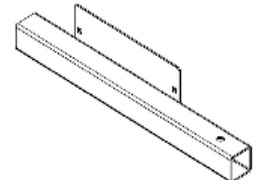

(1)
A0416
OUTER ENGINE
MOUNT ASSY.

A0674 WEIGHT KIT



(1)
HB0138
HARDWARE
BAG

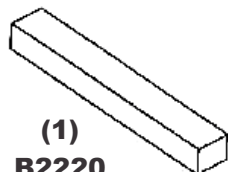

(1)
B2220
WEIGHT

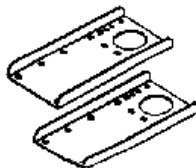

(2)
B0026
WEIGHT
BRACKET

A0664 BOOT KIT



(1)
HB0247
HARDWARE
BAG



(1)
B0309
BOOT
PLATE

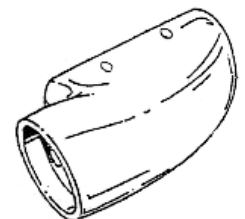

(1)
E0012
BOOT

2-7 Mount Tube Assembly Installation

Remove the (4) carriage bolts and (4) nuts from the rear plate. See Figure 2-7a. Remove the mower's rear plate and secure the outer engine mount assembly P#(A0416) to the rear of the mower using the existing (4) bolts and nuts. See Figure 2-7b.

Figure 2-7a.

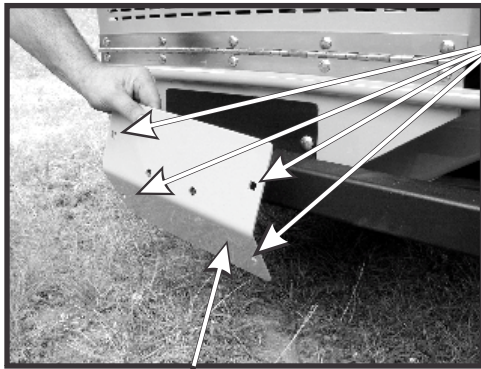

Remove (4)
Bolts And
(4) Nuts

Remove
Plate

Figure 2-7b.



Outer Engine
Mount Assy.

2-8 Engine Mount Arm Installation

Slide the engine mount arm assembly P#(A0318) (Figure 2-8) into the outer engine mount assembly. Secure the engine mount arm assembly using (1) detent pin P#(J0248).

Figure 2-8.

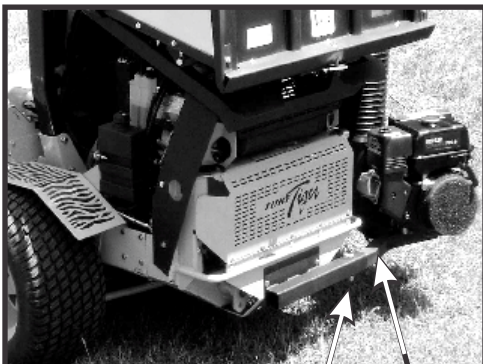

(1) Detent Pin

Engine Mount
Arm Assembly

2-9 Engine/Blower/Blade Assembly Installation

Place the engine/blower/blade assembly onto the engine mount arm assembly (Figure 2-9). Secure the engine/blower/blade assembly to the engine mount arm assembly by using (4) 5/16"-18 x 1-1/2" hex bolts P#(K1157) and (4) 5/16"-18 flange nuts P#(K1178).

Figure 2-9.

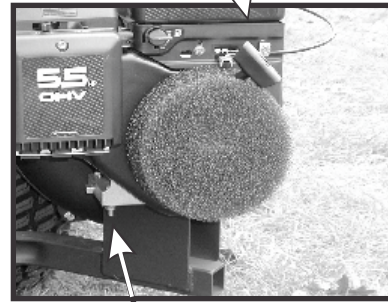

(4) 5/16"-18 x 1-1/2" Bolts
(4) 5/16"-18 Flange Nuts

2-10 Boot Installation

Mounting The Boot Plate

To mount the boot plate P#(B0309) to the boot P#(E0012) use (2) 3/8"-16 x 1" carriage bolts P#(K1182) and (2) 3/8"-16 flange nuts P#(K1215).

NOTE: Make certain when bolting the boot and boot plate together, that the head of the bolt is placed from the inside of the boot. This will prevent grass from collecting on the bolts.

To install the boot plate and boot to the deck, lift boot plate assembly to a 45 degree angle and slide bent tabs under the deflector shield as shown in Figure 2-10. Adjust boot as needed to insure proper fit.

The boot plate will allow you to switch from collection to discharge in seconds.

Figure 2-10.

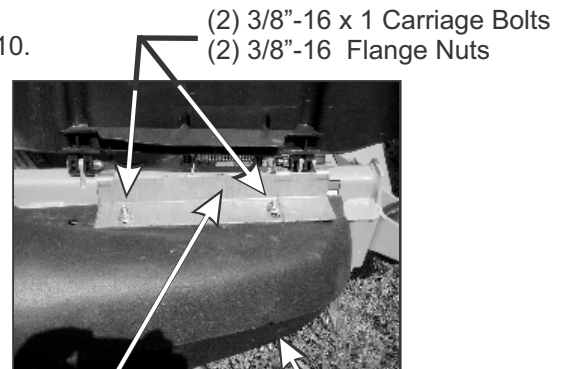

Boot Plate

Boot

2-11 Blower Cone Installation

Thread (1) 5/16"-18 jam nut P#(K0120) onto each end of (2) 5/16"-18 x 2-1/2" HHCS P#(K0125). Now partially thread the bolts into each of the two tabs located on the blower housing. Place blower cone so the two tabs line up with the bolts then tighten completely. See Figure 2-11.

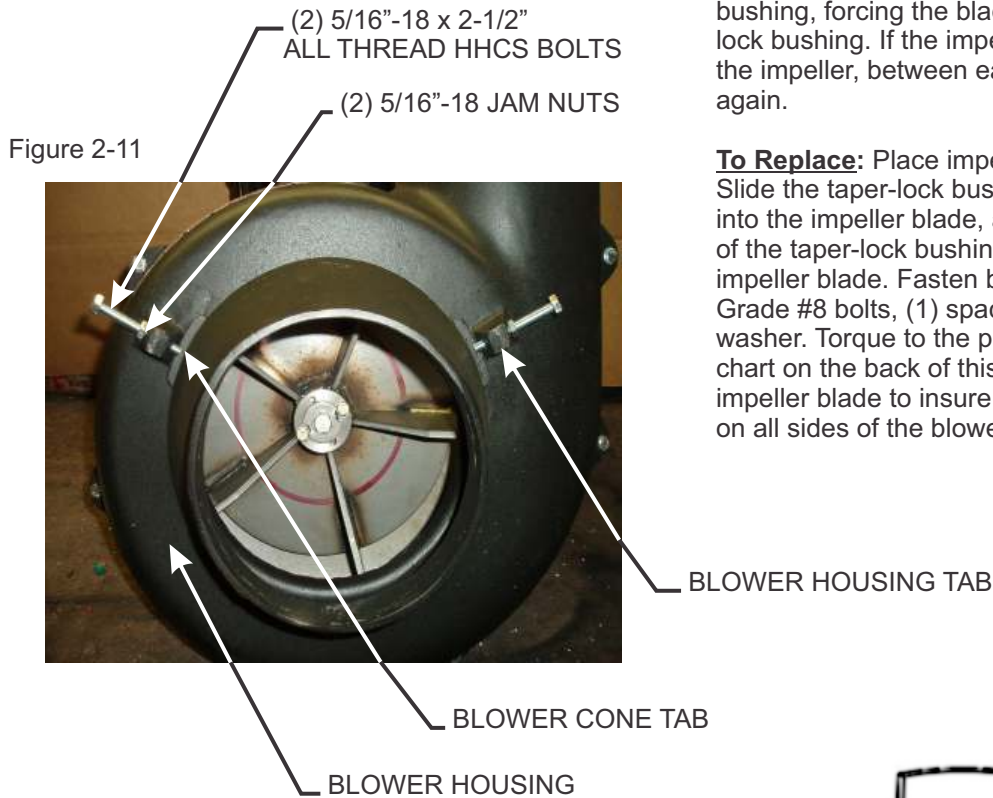

2-12 Impeller Blade Removal/Replacement

To Remove: First remove the center bolt (#1), washer (#2) and spacer (#3) from the taper-lock bushing (#5). See Figure 2-12. Next remove the (2) 1/4"-20 bolts (#4) and place them into the threaded holes of the taper-lock bushing (next to the holes they were removed from). Gradually thread each bolt evenly into the taper-lock bushing, forcing the blade to break-away from the taper-lock bushing. If the impeller will not move, hit the base of the impeller, between each vein, with a hammer, then try again.

To Replace: Place impeller blade over the engine shaft. Slide the taper-lock bushing on to the engine shaft and into the impeller blade, aligning the **non-threaded** holes of the taper-lock bushing to the threaded holes of the impeller blade. Fasten by using (2) 1/4"-20 HHCS Grade #8 bolts, (1) spacer washer and (1) HHCS bolt w/ washer. Torque to the proper specifications in the torque chart on the back of this manual. Next, rotate the impeller blade to insure that the blade is clear of contact on all sides of the blower housing.

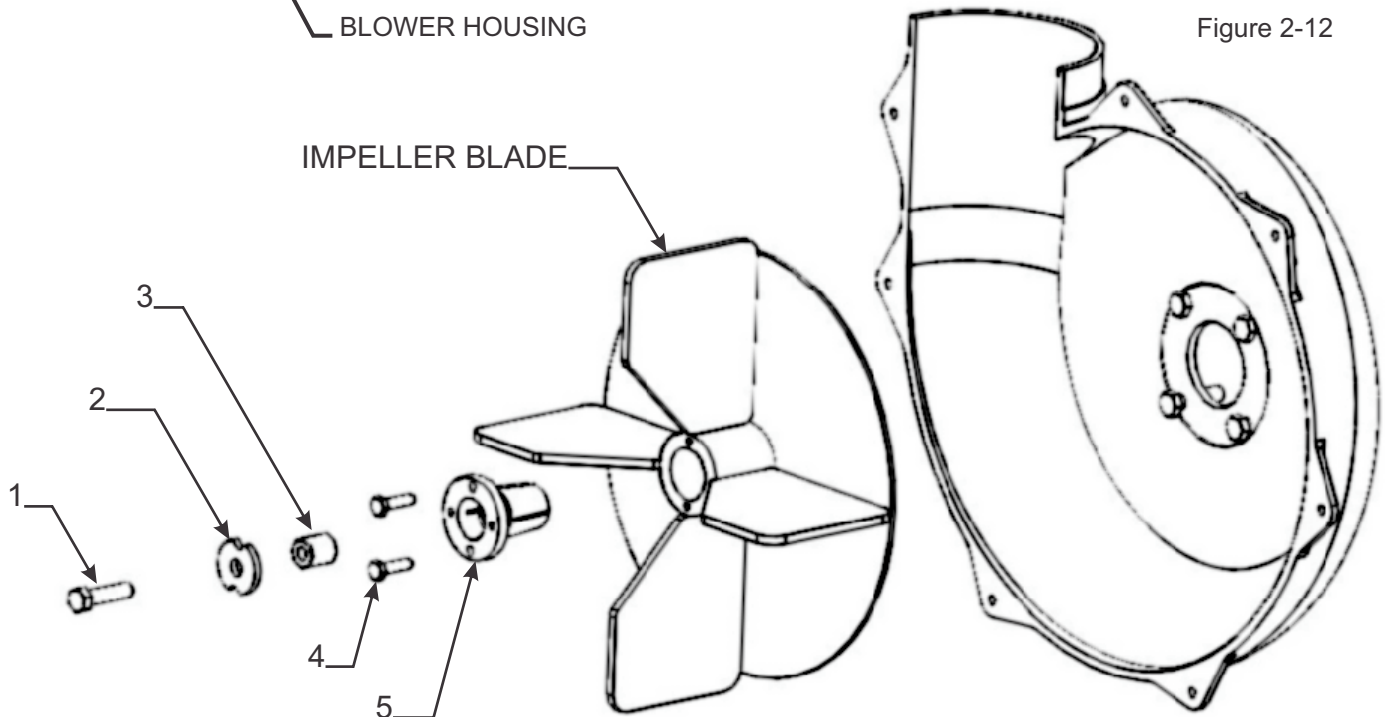

2-13 Length Of Hose Adjustment

The hoses in steps 2-14 and 2-15 must be cut to fit your machine. Follow steps 2-14 and 2-15. Do not cut the hoses until you have tried to fit them on your machine. Remember that the hoses have to be long enough to allow for enough clamping surface between the inlet, blower assembly, and the deck boot, but have to remain short enough to prevent hose "kinks".

2-14 Upper Hose Installation

Slide a 5"-6" upper hose clamp P#(J6011) onto both ends of the 6" upper hose (Figure 2-15). Then slide one end of the 6" hose onto the inlet. Make sure there is about a two-inch overlap between the hose end and the container inlet. Proceed to slide the opposite end of the 6" hose onto the outlet of the blower assembly. See Figure 2-15 for details. Make sure both ends of the hose are clearly attached to the inlet and the blower assembly inlet. Tighten the hose clamps.

2-15 Lower Hose To Blower Cone Installation

Slide a 7"-8" hose clamp P#(J6006) over both ends of the lower hose. Then proceed to slide the lower hose onto the blower cone. Tighten the hose clamp. The assembly should look like Figure 2-15.

Figure 2-15.

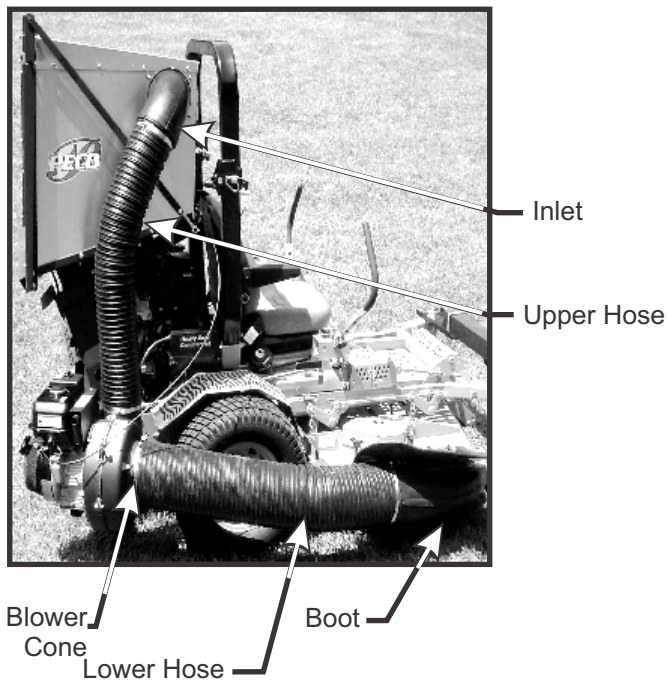

2-16 Lower Hose To Boot Installation

Take the unattached end of the lower hose and slide it over the circular end of the boot. Use the lower hose clamp to secure the hose to the boot (Figure 2-16). Tip: Before securing clamp rotate hose counter-clockwise (away from yourself) approximately 1" to add in retaining boot to mower deck.

Figure 2-16.

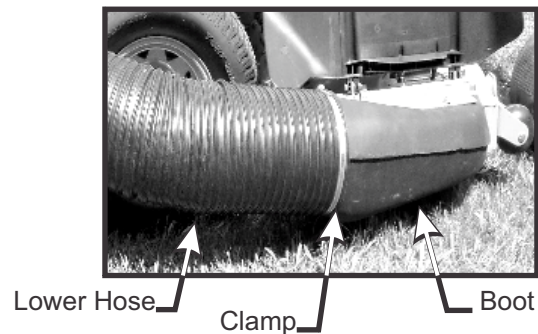

2-17 Front Weight Installation

Place (1) weight bracket P#(B0026) over each front caster. Fasten each weight bracket to the front caster loosely, by using (1) 3/8"-16 x 3-1/2" u-bolt P#(K0286) and (2) 3/8"-16 flange nuts P#(K1215) per bracket. When installing the weight you should have another person help position the weight onto a floor jack. Using the floor jack will make installing the weight much easier. Lift the weight up to the top side of the weight brackets. Fasten the weight to the weight brackets by using (1) 1/2"-13 u-bolt P#(K0331) and (2) 1/2"-13 flange nuts P#(K1246) per bracket. Once the weight is secure tighten all nuts. Use Figure 2-17 for more detail.

Figure 2-17.

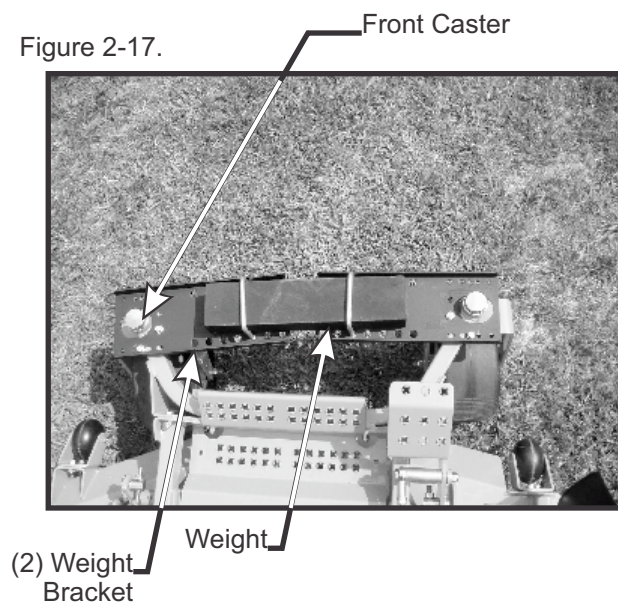

2-18 Throttle Cable Installation

To install the throttle cable kit to the box assembly, align the large end of the slot in the throttle base plate (Figure 2-18a) with the rivets located on the front of the box assembly frame (Figure 2-18b). Place the throttle base plate over the rivets, Slide the throttle cable kit to the right, moving the smaller end of the slot over the rivets. When positioned correctly, the throttle spring plate will snap into place (Figure 2-18c).

To remove the throttle cable kit, lift the throttle spring plate and slide the throttle kit to the left.

Route cable under upper hose as shown in Figure 2-18d.

Figure 2-18a.

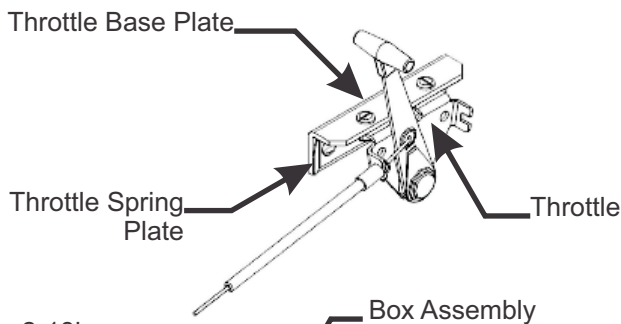
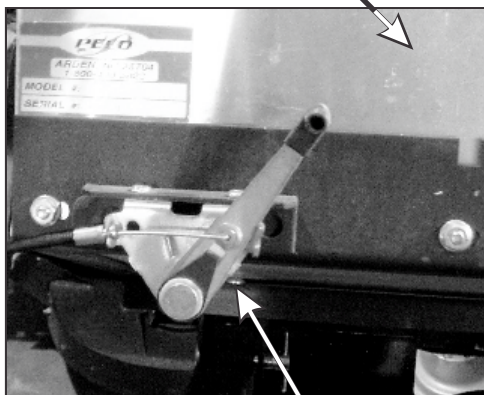

Figure 2-18b.



Rivet

Figure 2-18c.



Box Assembly

Throttle Cable Kit
Properly Positioned

Figure 2-18d.

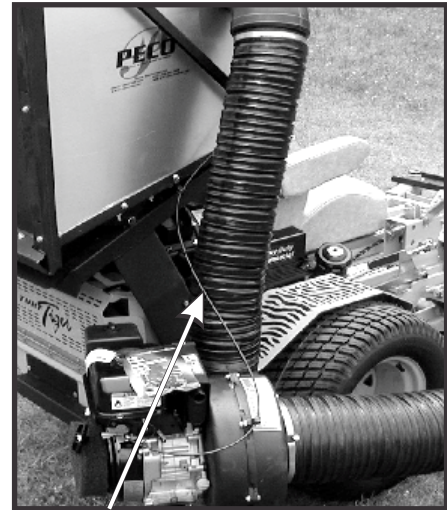

Throttle Cable

To fasten the throttle cable end to the engine, place the throttle control lever into the "stop" position. Rotate the engine throttle lever to the "stop" position. Thread the wire end of the throttle cable into the engine throttle lever eyelet and tighten the screw. Fasten the throttle cable sleeve to the clamp on the engine throttle (Figure 2-18e). Rotate the throttle control lever into the "fast" position to check for proper installation.

NOTE: Cable sleeve may need to be cut, depending on the engine type. Once throttle cable is attached, pull the box handle to dump the box and be sure the cable does not alter the movement of the box.

Cable Clamp

Figure 2-18e.



Engine Throttle Lever

SECTION III

OPERATING INSTRUCTIONS

3-1 General Safety

Only qualified people familiar with this operator's manual and the mower's operator's manual should operate this machine.

3-2 Operation & Tips On Mowing

- A. Perform BEFORE EACH USE maintenance list in paragraph 4-1.
- B. Start the engine/blower/blade assembly.
- B. Start mower.
- C. With the mower at high idle speed, engage the mower deck.
- D. Proceed to operate the control levers of the mower.

Note: If the collection system does not appear to be collecting the grass clippings; disengage the deck, and blower, engage the parking brake and turn the mower off. Check the upper hose, lower hose, top screen and boot for clogs.

To obtain the maximum effectiveness from your collection system the tips listed below should be followed:

- * Watch your speed- Normal conditions will allow a speed of up to approximately 5 mph, but thick, heavy damp conditions will require reduced ground speed.
- * Mow with sharp blades- A sharp blade cuts cleaner.
- * Wet grass and leaves will decrease effectiveness and will increase horsepower requirements.
- * Mow at higher cutting heights- Remove and mulch no more than 2" of grass length with each mowing. (Experts recommend not cutting off more than 1/3 of the grass blade length at any given time.)
- * Mow twice, at different height settings, (high, then low), if grass is extra tall.
- * Remember that horsepower requirements will vary with the mowing conditions such as type and height of turf grass, moisture content, amount of leaves, whether the terrain is flat or sloped, etc.

3-3 Unloading The Collection System

Note: Press the tab, located behind the operator's left side, downward to feel if the collection system is full. If the container is full there will be resistance when depressing the tab.

- A. Stop the forward movement of the mower.
- B. Disengage the mower deck.
- C. Using the throttle cable slow the engine down to idle.
- D. Push the dump handle, on the left of the operator, away from the unit. While holding the handle pushed away, move the handle upward. The container door will swing upward and the container will rotate downward. The container will release its contents.
- E. Once the contents of the container have fallen out, the container is ready to move back into its normal operating position. With the handle in the 'away' position, pull the handle downward until it stops. Move the handle towards the center of the mower. This motion will allow the latch to lock back into collection position.

Note: If you do not hold the handle away from the mower as you pull the handle downward, the latch will not lock and the container can unexpectedly release the contents collected.

SECTION IV

MAINTENANCE

4-1 Maintenance Checklist

Before each use:

1. Check blades and spindles to be sure that no foreign objects, such as wire or steel strapping bands, are wrapped around them.
2. Inspect blades for wear. Replace if necessary. If it is necessary to sharpen the blades, remove the blades from the spindles before sharpening. DO NOT sharpen blades while still attached to the mower.
3. Make sure all shields are in place and in good condition. Repair or replace any missing or damaged shields.
4. Listen for abnormal sounds, which might indicate loose parts, damaged bearings, or other damage. Correct any deficiency before continuing operation.
5. Check for wear or deterioration of the upper or lower hoses. If there are any portions of the hose that have been torn or worn through, replace with genuine PECO parts.

After Each Use:

1. Clean all debris from machine especially from the container, and off of safety decals. Replace any missing or illegible decals.
2. Clean all debris from the box screen.
3. Inspect unit for worn or damaged components. Repair or replace before the next use. Any replacement component installed during repair shall include the components current safety decal specified by the manufacturers to be affixed to the component.

SECTION V PARTS AND SERVICE

5-1 Parts And Service Information

PECO collection system owners should record the name and telephone number of their Service Center. Your Service Center will be happy to supply replacement parts, accessories, and do any service or repairs to your collection system. If for any reason your Service Center is unable to service your collection system or supply replacement parts, contact PECO and include the following information on the chart below.

THE SERIAL NUMBER PLATE IS LOCATED ON THE ALUMINUM BOX NEAR THE DUMP HANDLE

PECO	
OUTDOOR POWER EQUIPMENT	
Model Number	<input type="text"/>
Serial Number	<input type="text"/>
Arden, North Carolina 28704	

WRITE THE MODEL AND SERIAL NUMBER IN THE BOX ABOVE FOR FUTURE REFERENCE.

Turn any PECO Lawn Vac into a total lawn grooming tool with the PECO Wand Kit!

With your PECO Wand Attachment you will double the ability of your PECO Lawn Vac. Using the same powerful vacuum/blower that makes your Lawn Vac work so well, you will be able to get to all those hard-to-reach places where you needed a rake or broom before.

Contact PECO Today!



Unit Model Number: _____

Unit Engine Size: _____

Unit Serial Number: _____

Date of purchase: ____/____/____

Dealer/Distributor Name: _____

Address: _____ **State:** _____ **Zip:** _____

Phone Number: _____

Address: PECO Inc.
P.O. Box 1197
Arden, NC 28704

Phone #: (828) 684-1234 or Toll Free: (800) 438-5823

Email: peco@lawnvac.com

SAFETY DECALS

To promote safe operation, PECO supplies safety decals on all products manufactured. Damage can occur to safety decals either through shipment, use or reconditioning. Contact your local Service Center for replacement decals.



Part #: R4027



Part #: R1069



Part #: R1053



Part #: R1049

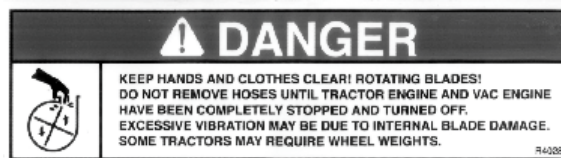

Part #: R4028



Part #: R1057



Part #: R1054



Part #: R1055



Part #: R4015



Part #: R4054



Part #: R1065



Part #: R4008



Part #: R1051



Part #: R1070

TORQUE SPECIFICATIONS

Proper torque for American fasteners used on Peco equipment.
Recommended Torque in Foot Pounds (Newton Meters).*

AMERICAN Bolt Head Markings

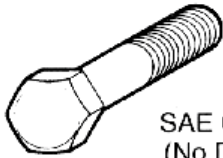

SAE Grade 2
(No Dashes)

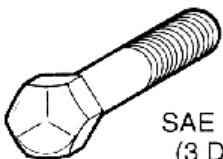

SAE Grade 5
(3 Dashes)

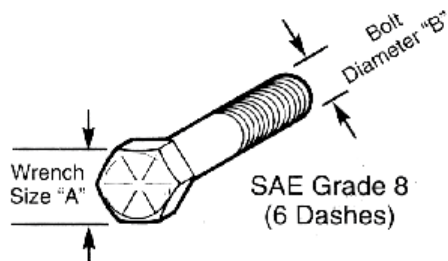

SAE Grade 8
(6 Dashes)

WRENCH SIZE (IN.) "A"	BOLT DIAMETER (IN.) "B" AND THREAD SIZE	SAE GRADE 2	SAE GRADE 5	SAE GRADE 8
7/16	1/4 - 20 UNC	6 (7)	8 (11)	12 (16)
7/16	1/4 - 28 UNF	6 (8)	10 (13)	14 (18)
1/2	5/16 - 18 UNC	11 (15)	17 (23)	25 (33)
1/2	5/16 - 24 UNF	13 (17)	19 (26)	27 (37)
9/16	3/8 - 16 UNC	20 (27)	31 (42)	44 (60)
9/16	3/8 - 24 UNF	23 (31)	35 (47)	49 (66)
5/8	7/16 - 14 UNC	32 (43)	49 (66)	70 (95)
5/8	7/16 - 20 UNF	36 (49)	55 (75)	78 (106)
3/4	1/2 - 13 UNC	49 (66)	76 (103)	106 (144)
3/4	1/2 - 20 UNF	55 (75)	85 (115)	120 (163)
7/8	9/16 - 12 UNC	70 (95)	109 (148)	153 (207)
7/8	9/16 - 18 UNF	79 (107)	122 (165)	172 (233)
15/16	5/8 - 11 UNC	97 (131)	150 (203)	212 (287)
15/16	5/8 - 18 UNF	110 (149)	170 (230)	240 (325)
1-1/8	3/4 - 10 UNC	144 (195)	266 (360)	376 (509)
1-1/8	3/4 - 16 UNF	192 (260)	297 (402)	420 (569)
1-5/16	7/8 - 9 UNC	166 (225)	430 (583)	606 (821)
1-5/16	7/8 - 14 UNF	184 (249)	474 (642)	668 (905)
1-1/2	1 - 8 UNC	250 (339)	644 (873)	909 (1232)
1-1/2	1 - 12 UNF	274 (371)	705 (955)	995 (1348)
1-1/2	1 - 14 UNF	280 (379)	721 (977)	1019 (1381)
1-11/16	1-1/8 - 7 UNC	354 (480)	795 (1077)	1288 (1745)
1-11/16	1-1/8 - 12 UNF	397 (538)	890 (1206)	1444 (1957)
1-7/8	1-1/4 - 7 UNC	500 (678)	1120 (1518)	1817 (2462)
1-7/8	1-1/4 - 12 UNF	553 (749)	1241 (1682)	2013 (2728)
2-1/16	1-3/8 - 6 UNC	655 (887)	1470 (1992)	2382 (3228)
2-1/16	1-3/8 - 12 UNF	746 (1011)	1672 (2266)	2712 (3675)
2-1/4	1-1/2 - 6 UNC	870 (1179)	1950 (2642)	3161 (4283)
2-1/4	1-1/2 - 12 UNF	979 (1327)	2194 (2973)	3557 (4820)

METRIC

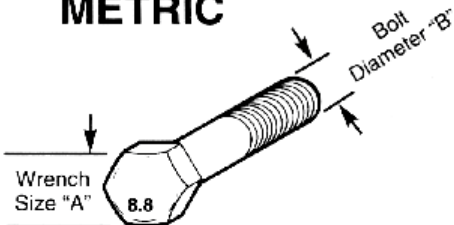

Numbers appearing on bolt heads indicate ASTM class.

Proper torque for metric fasteners used on Peco equipment.
Recommended torque in foot pounds (newton Meters).*

WRENCH SIZE (mm) "A"	BOLT DIA. (mm) "B"	ASTM 4.6	ASTM 8.8	ASTM 9.8	ASTM 10.9
8	5	1.8 (2.4)		5.1 (6.9)	6.5 (8.8)
10	6	3 (4)		8.7 (12)	11.1 (15)
13	8	7.3 (10)		21.1 (29)	27 (37)
16	10	14.5 (20)		42 (57)	53 (72)
18	12	25 (34)	74 (100)	73 (99)	93 (126)
21	14	40 (54)	118 (160)	116 (157)	148 (201)
24	16	62 (84)	167 (226)	181 (245)	230 (312)
30	20	122 (165)	325 (440)		449 (608)
33	22		443 (600)		611 (828)
36	24	211 (286)	563 (763)		778 (1054)
41	27		821 (1112)		1138 (1542)
46	30	418 (566)	1119 (1516)		1547 (2096)

*Use 75% of the specified torque value for plated fasteners. Use 85% of the specified torque values for lubricated fasteners.



**P.O. BOX 1197
ARDEN, NORTH CAROLINA 28704
(800) 438-5823 OR (828) 684-1234 FAX: (828) 684-0858
EMAIL: peco@lawnvac.com
WEBSITE: www.lawnvac.com**