



Pack Drawing

Bush Hog - ZT Professional Series, ZT Estate Commercial Series & ZT Estate Series

Owner's Manual: Q0489(PZ & EC) & Q0499(ES)

Vac/Drive Type: P3B (15 Cu. Ft.) PTO Driven

Revision #: Initial Release (8/18/2014)

Fits Year(s): 2013-2015

47131504 (PZ Series)

HB0636 Engine Pulley Kit

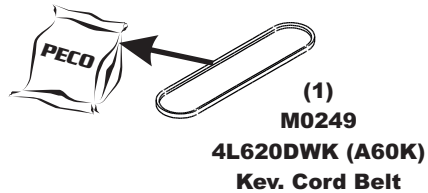

47131503 (EC Series)

HB0637 Engine Pulley Kit

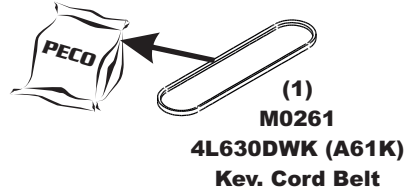

47131502 (ES Series)

HB0638 Engine Pulley Kit

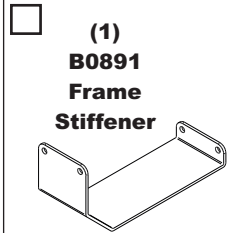
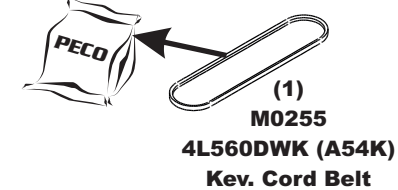

A2006 Weight Kit

(1)
HB0639
Hardware
Bag

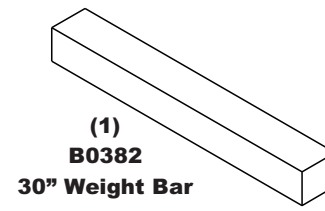
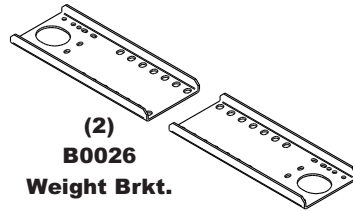

A2007 Weight Kit

(1)
HB0229
Hardware
Bag

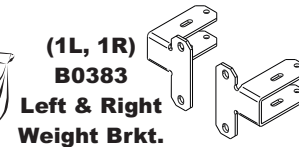

A2008 P3B PTO Universal Kit

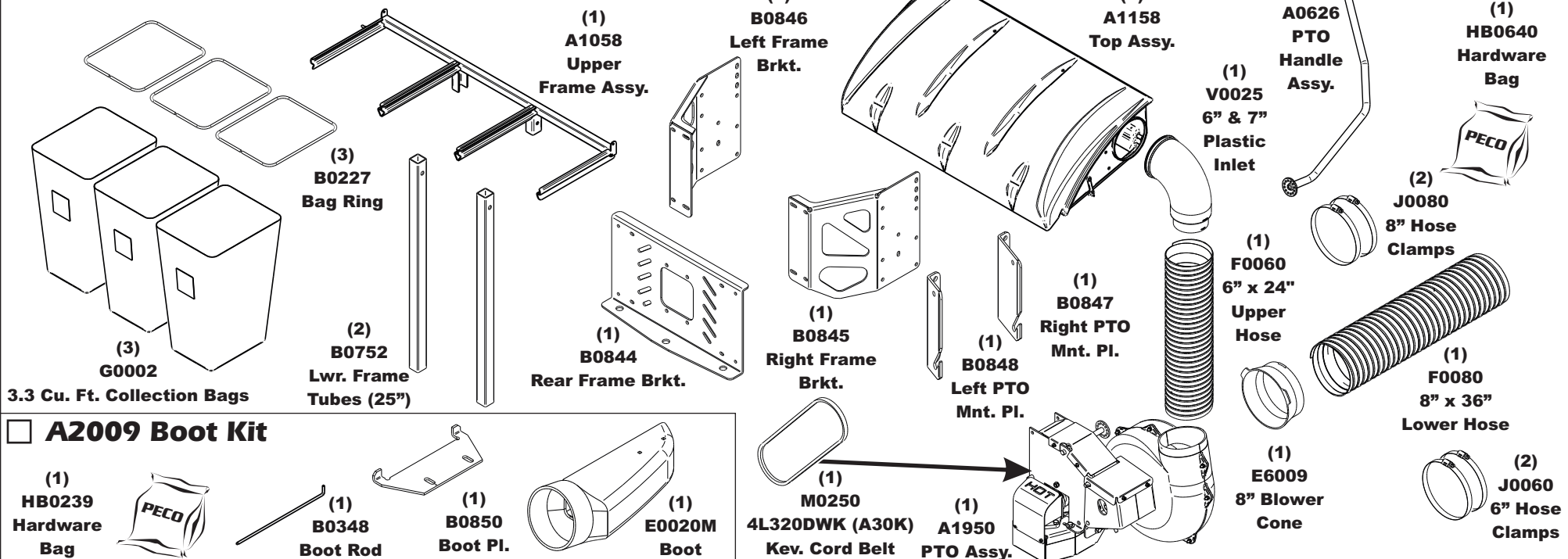

A2009 Boot Kit