

MODEL#: 46131503

Mower & Type: HUSQVARNA PZ

Deck Size & Type: 54" & 60" Decks

Vac/Drive Type: P3B - Engine Driven BR6.5V

Fits Year(s): 2010-2014

Owner's Manual: Q0398

Revisions: 1 - E1902 changed to E0123 - 6/2/2014 - JPP

2 - Model # was 46031501 - 9/3/2014 - JPS



A1745 UNIT ASSEMBLY

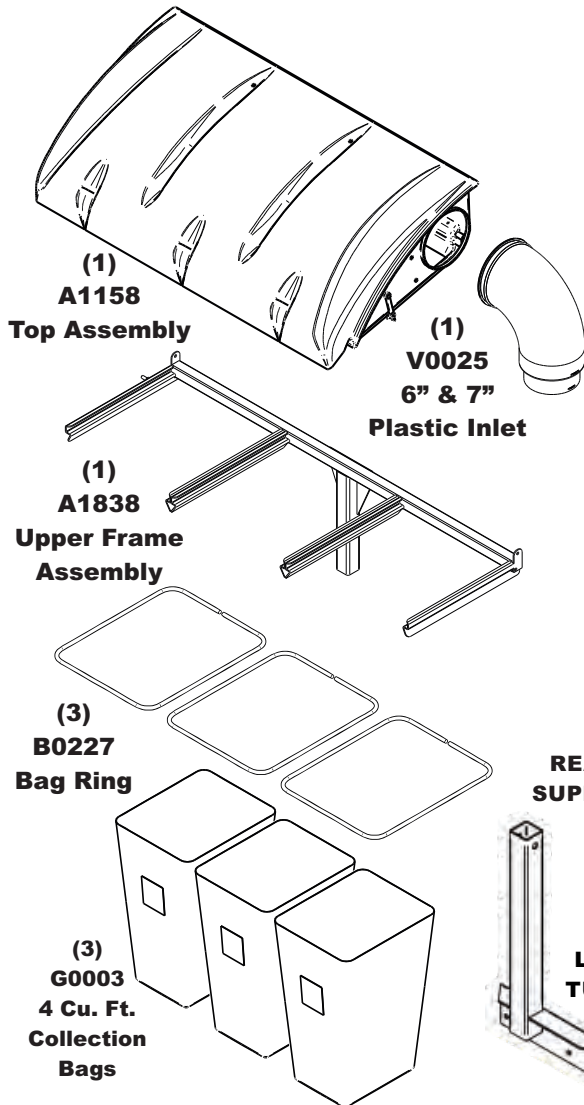

(1)
A1158
Top Assembly

(1)
V0025
6" & 7"
Plastic Inlet

(1)
A1838
Upper Frame
Assembly

(3)
B0227
Bag Ring

(3)
G0003
4 Cu. Ft.
Collection
Bags



(1)
8" x 40"
LOWER
HOSE



(1)
6" x 26"
UPPER
HOSE

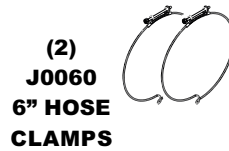

(2)
J0060
6" HOSE
CLAMPS



(2)
J0080
8" HOSE
CLAMPS

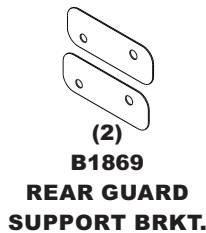

(2)
B1869
REAR GUARD
SUPPORT BRKT.

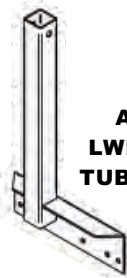

(1)
A1720
LWR. MNT.
TUBE ASSY.

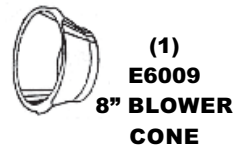

(1)
E6009
8" BLOWER
CONE

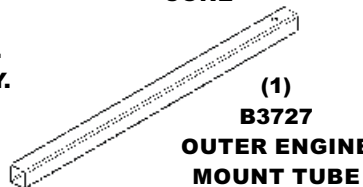

(1)
B3727
OUTER ENGINE
MOUNT TUBE

A0620 THROTTLE KIT



(1)
A0666
THROTTLE
MNT. PL.
ASSY.



(1)
A0060
70" THROTTLE
KIT FOR
(5.5 & 6.5 HP)



(1)
HB0249
HARDWARE
BAG



(1)
A0942
ENGINE MOUNT
ARM ASSY.



(1)
HB0402
HARDWARE
BAG

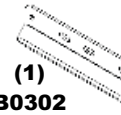

(1)
B0302
LWR. MNT.
CLAMP BRKT.



(2)
B0583
ENGINE MNT.
TUBE PL.

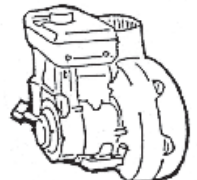

(1)
A639
ENGINE/
BLOWER/
BLADE ASSY.

A1746 - WEIGHT KIT

(2)
B0026
WEIGHT
BRACKETS

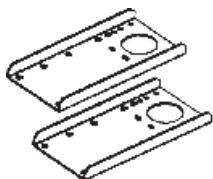

(1)
HB0403
HARDWARE
BAG



(1)
B2220
WEIGHT



A1747 - 60" BOOT KIT

(1)
HB0404
HARDWARE
BAG



(1)
B0348
BOOT ROD

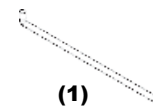

(1)
B0581
BOOT PLATE



(1)
E0123
BOOT

