

# MODEL#: 22120901

**MOWER NAME: TORO**

**MOWER MODEL: TITAN SERIES**

**MOWER DECK SIZE: 48" 54" AND 60" DECKS**

**VAC NAME: PRO 2 BAGGER**

**PTO DRIVEN**

**MANUAL #Q0405**

**A1780 UNIT ASSEMBLY**



FOR YEAR: 2009 - 2012

REVISED: 9/25/2013

**FITS THESE MOWER MODELS:** 2009 - 74822 (ZX5400), 74823 (ZX6000), 74824 (ZX6050)  
2010 - 74830 (ZX4800), 74832 (ZX5450), 74833 (ZX6050) and 74824 (ZX6050)

2011 - 2012 - 74841 (ZX4820), 74842 (ZX5420), 74843 (ZX6020)

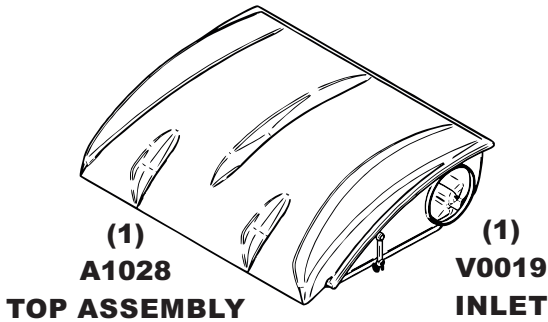

(1) **A1028 TOP ASSEMBLY**  
(1) **V0019 INLET**



(4) **J0060 6" HOSE CLAMPS**



(1) **F0060 6" x 22" UPPER HOSE**

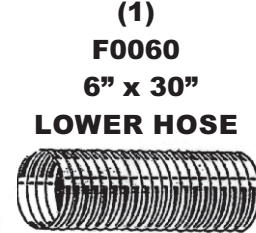

(1) **F0060 6" x 30" LOWER HOSE**



(1) **HB0416 UNIT HARDWARE BAG**

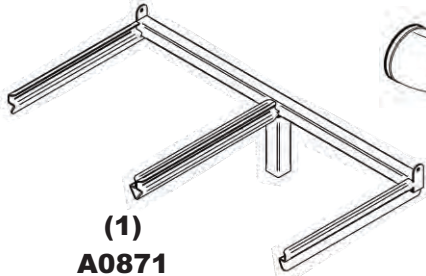

(1) **A0871 UPPER FRAME ASSEMBLY**

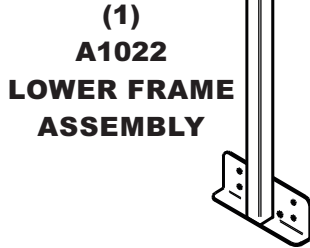

(1) **A1022 LOWER FRAME ASSEMBLY**

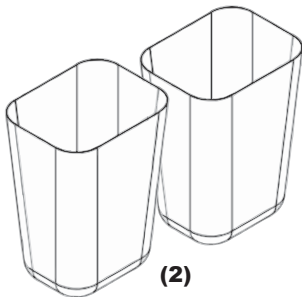

(2) **G0004 2.9 CU. FT. COLLECTION BAGS**

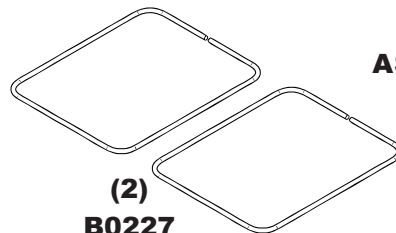

(2) **B0227 BAG RING**

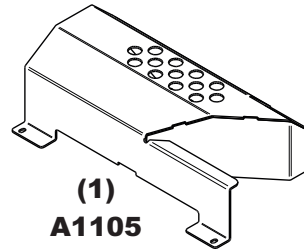

(1) **A1105 MUFFLER GUARD ASSEMBLY**



(1) **M0239 A56K KEVLAR BELT**



(1) **HB0417 ENGINE PULLEY HARDWARE BAG**

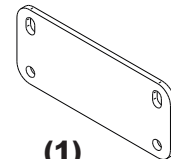

(1) **B0608 PTO MOUNT SPACER**

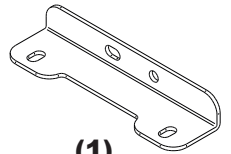

(1) **B0606 LOWER FRAME MOUNT**

**A1781 BOOT KIT**



(1) **HB0418 HARDWARE BAG**

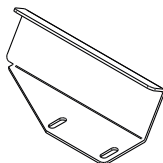

(1) **B0605 BOOT PLATE**

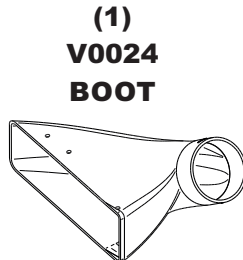

(1) **V0024 BOOT**



(1) **V0016 BLOWER CONE 6"**

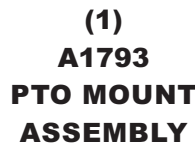

(1) **A1793 PTO MOUNT ASSEMBLY**

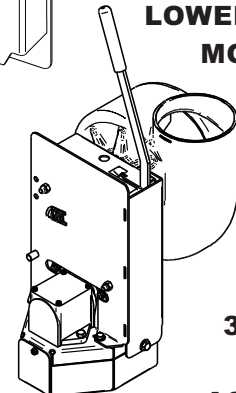

(1) **A1840 3-BLADE PTO ASSEMBLY**