

# MODEL#: 35621217

**MOWER NAME: EXMARK**

**MOWER MODEL: LAZER Z NEXT GENERATION**

**MOWER DECK SIZE: 48" 52" 60" & 72"**

**VAC NAME: 12 CUBIC FOOT BOX**

**ENG: 900 SER. BR (9.00 GROSS TORQUE / 205 cc)**

**MANUAL: Q0384**



**FOR YEAR: 2009 - 2015**

**REVISED: 2/2/2016**

## **A1703 - UNIT ASSEMBLY**

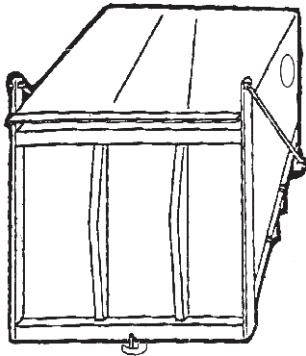

(1)  
**A0794**  
12 CU. FT. BOX  
ASSEMBLY



(1)  
**V1054**  
INLET



(2)  
**J0060**  
6" HOSE  
CLAMPS



(2)  
**J0080**  
8" HOSE  
CLAMPS



(1)  
**HB0369**  
HARDWARE  
BAG

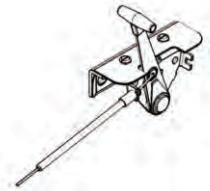

**A0060 - THROTTLE  
CABLE KIT (70")**

(1)  
**A0601**  
MAIN FRAME  
ASSEMBLY

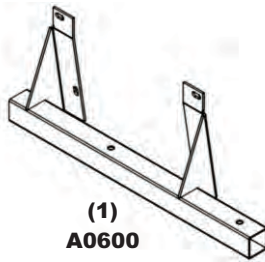
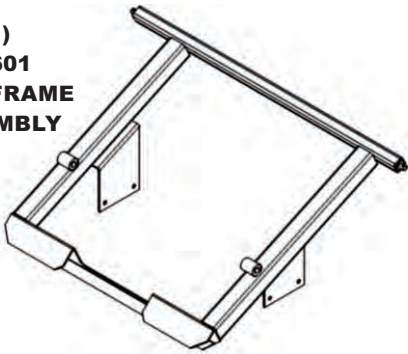

(1)  
**A0600**  
OUTER ENGINE  
MOUNT TUBE  
ASSEMBLY



(1)  
**6" x 31"**  
UPPER  
HOSE



(1)  
**8" x 42"**  
LOWER  
HOSE

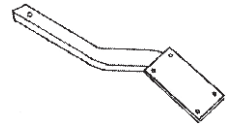

(1)  
**A0318**  
MOTOR MOUNT  
ARM ASSY.



(1)  
**E6009**  
8" BLOWER  
CONE

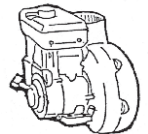

(1)  
**ENGINE/BLOWER  
BLADE ASSY.**



(2)  
**B2526**  
DOOR LINKAGE



(1)  
**A0273**  
BOX HANDLE

(1) **B0529 LEFT &  
(1) B0528 RIGHT**  
LOWER MAIN  
FRAME LEGS

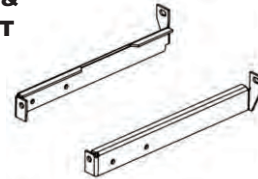

## **A0641 - BOOT KIT**

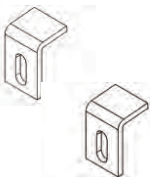

(2)  
**B0538**  
BOOT PLATE



(1)  
**HB0207**  
HARDWARE  
BAG

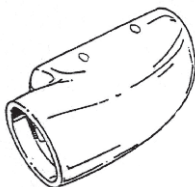

(1)  
**E1039**  
BOOT

## **A0665 - WEIGHT KIT**

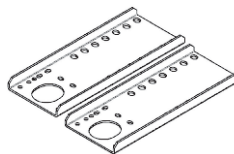

(2)  
**B0026**  
WEIGHT  
BRACKETS

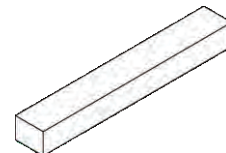

(1)  
**B2220**  
WEIGHT BAR



(1)  
**HB0370**  
HARDWARE  
BAG