



# Unit Model #: 06621245

**Mower & Type:** John Deere Z915B, Z920M, Z920R, Z925M EFI, Z930R

**Engine Type:** Kohler - CV740, FCV740 / Kawasaki - FX730V, FX801V

**Deck Size & Type:** 54" 7 Iron II - Commercial

**Vac Type:** Pro 12 DFS (12 Cu. Ft.)

**Owner's Manual:** Q0476

**Drive Type:** Briggs & Stratton 6.5HP Vanguard

**Revision #:** Final Release 10/31/2013

**Fits Year(s):** 2013 & Newer

## A1967 Vac Kit

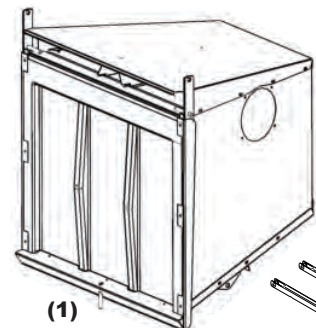

(1)  
**A0794**  
Box  
Assembly



(1)  
**V1054**  
Plastic  
Inlet

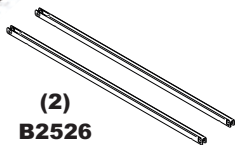

(2)  
**B2526**  
Door Linkage



(1)  
**F0060**  
6" x 40"  
Upper Hose



(2)  
**J0060**  
6" Hose  
Clamps



(1)  
**HB0593**  
Vac Kit  
Hardware Bag

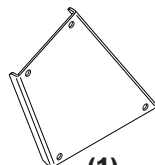

(1)  
**B0870**  
Lt. Main  
Frame Leg

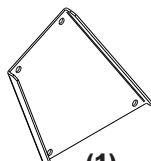

(1)  
**B0871**  
Rt. Main  
Frame Leg

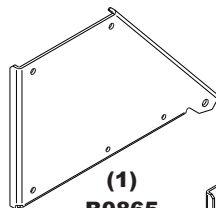

(1)  
**B0865**  
Lt. Frame  
Bracket

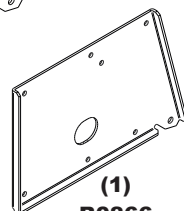

(1)  
**B0866**  
Rt. Frame  
Bracket

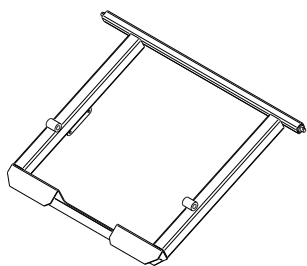

(1)  
**A1192**  
Main Frame  
Assembly

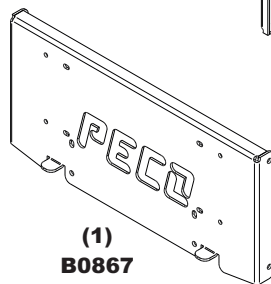

(1)  
**B0867**  
Rear Frame  
Bracket

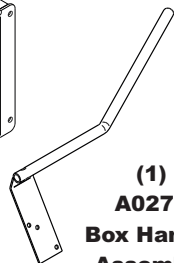

(1)  
**A0273**  
Box Handle  
Assembly

## A1972 Mount Kit

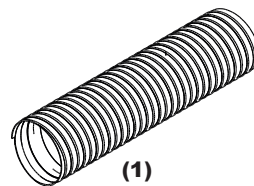

(1)  
**F0070**  
7" x 40"  
Lower Hose



(2)  
**J0070**  
7" Hose  
Clamps



(1)  
**HB0594**  
Mount Kit  
Hardware Bag

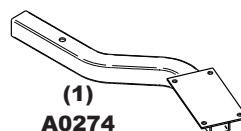

(1)  
**A0274**  
Engine Mount  
Arm Assembly

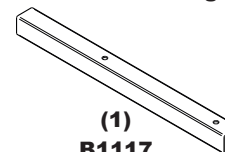

(1)  
**B1117**  
Outer Engine  
Mount Tube

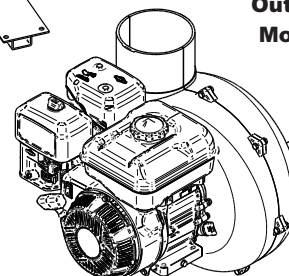

(1)  
**A639**  
Engine/Blower  
Blade Assy.

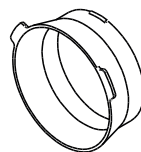

(1)  
**E6004**  
7" Blower  
Cone

## A0619 Throttle Kit

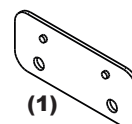

(1)  
**A0666**  
Throttle  
Mnt. Pl.  
Assembly

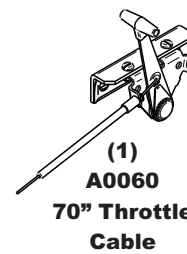

(1)  
**A0060**  
70" Throttle  
Cable



(1)  
**HB0249**  
Hardware  
bag

## A1771 54 inch Boot Kit



(1)  
**HB0412**  
Hardware  
Bag

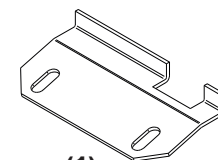

(1)  
**B0001**  
Boot Plate

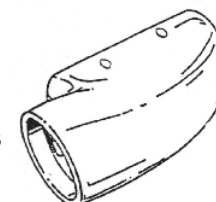

(1)  
**E1103**  
Boot

## A2140 Weight Kit

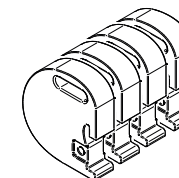

(4)  
**Y0025**  
28 lbs  
Suitcase  
Weight



(1)  
**B1016**  
Weight  
Bracket



(1)  
**HB0699**  
Weight Kit  
Hardware  
Bag