

MODEL#: 22131540

MOWER NAME: TORO G3, 3000, 5000 & 6000 SERIES

MODELS: 74952, 53, 54, 01, 03, 15, 30, 22, 23, 25, 26, 36

DECK: 48", 52" & 60"

VAC NAME: 15 CUBIC FOOT PRO BAGGER

ENG: BRIGGS & STRATTON 6.5 VANGUARD

MANUAL: Q0385



FOR YEAR: 2008-2013

REVISED: 7/15/13

A1706 UNIT ASSEMBLY

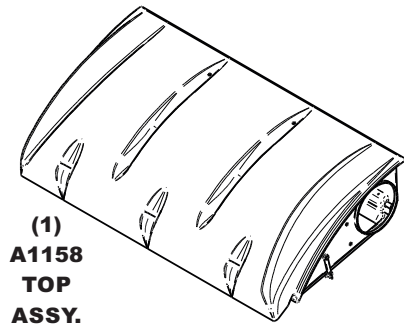

(1)
A1158
TOP
ASSY.

(1)
V0025
6" & 7"
PLASTIC
INLET



(1)
8" x 35"
LOWER
HOSE



(1)
6" x 30"
UPPER
HOSE

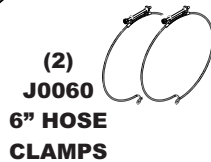

(2)
J0060
6" HOSE
CLAMPS



(2)
J0060
6" HOSE
CLAMPS



(1)
E6009
8" BLOWER
CONE

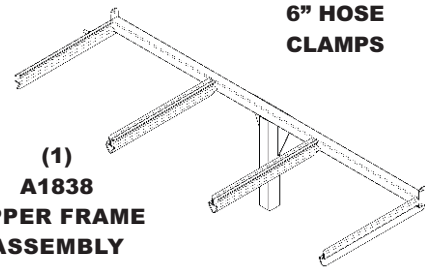

(1)
A1838
UPPER FRAME
ASSEMBLY



(1)
A0274
ENGINE MOUNT
ARM ASSY.



(1)
HB0374
HARDWARE
BAG

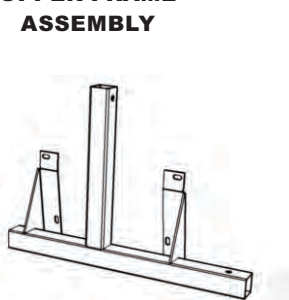

(1)
A0605
OUTER ENGINE
MNT. TUBE ASSY.

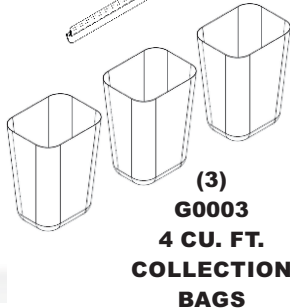

(3)
G0003
4 CU. FT.
COLLECTION
BAGS



(1)
C0061
EXHAUST
DEFLECTOR

(1) B0529 LEFT
LOWER MAIN
FRAME LEG

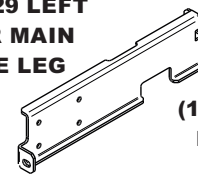

(1) B0528 RIGHT
LOWER MAIN
FRAME LEG

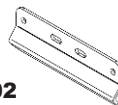
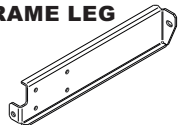

(1)
B0302
LWR. MNT.
CLAMP BRKT.

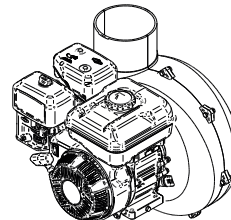

(1)
A639
ENGINE/
BLOWER/
BLADE ASSY.

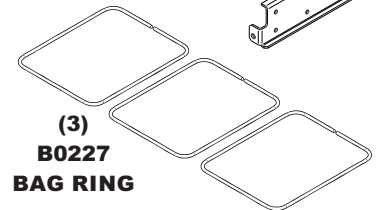

(3)
B0227
BAG RING

A0665 - WEIGHT KIT

(2)
B0026
WEIGHT
BRACKETS

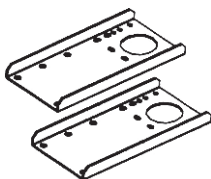

(1)
HB0370
HARDWARE
BAG



(1)
B2220
WEIGHT

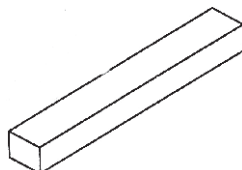

A0640 - 60" BOOT KIT

(1)
HB0207
HARDWARE
BAG



(1)
B0537
BOOT PLATE

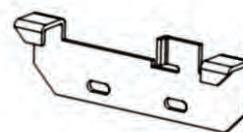

(1)
E1039
BOOT

