



**Unit Model #: 38120902**

**Mower & Type:** Dixie Chopper Magnum

**Mower Models:**

**Deck Size/Model:** 44"

**Owner's Manual:** Q0444 Rev. 2

**Vac/Drive Type:** P2B+ (9 Cu. Ft.) PTO Driven

**Revision #:**

**Fits Year(s):** 2012-2014

**A1997 Vac Kit**

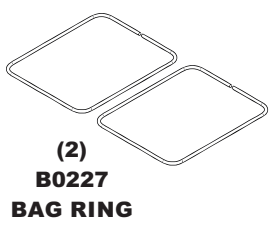
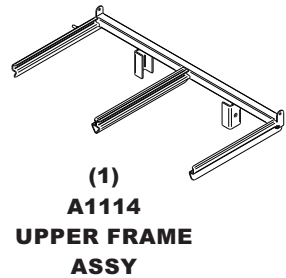
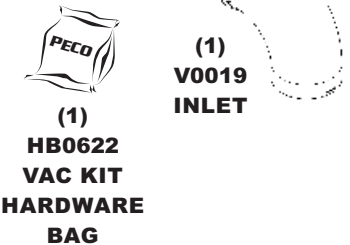
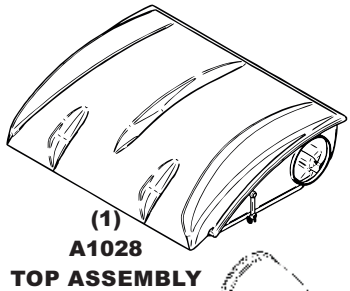

**A2073 Mount Kit**

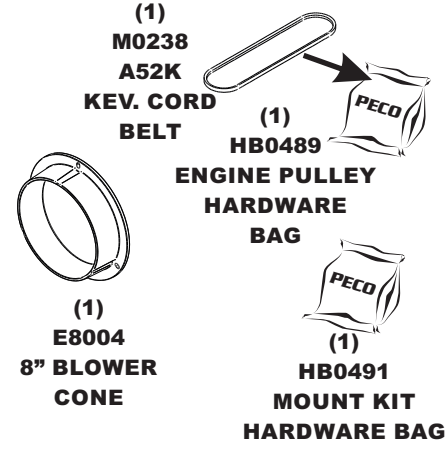
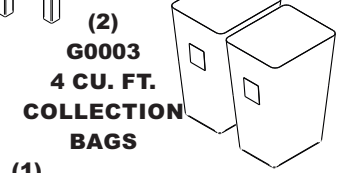
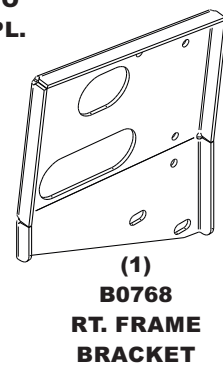
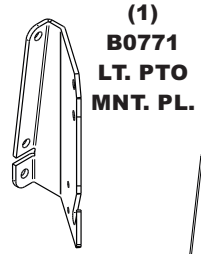
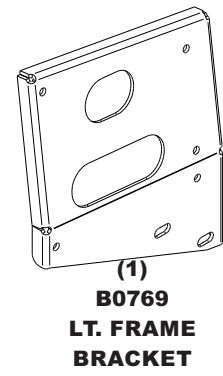
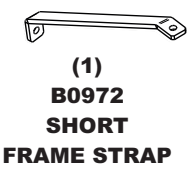
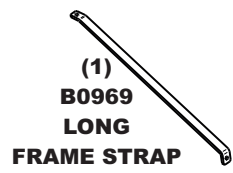
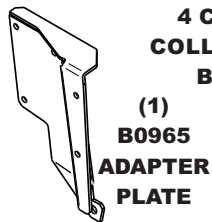
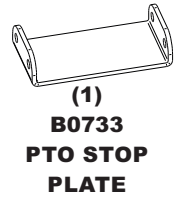
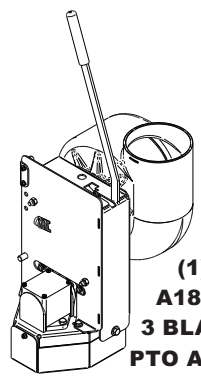
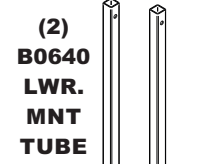
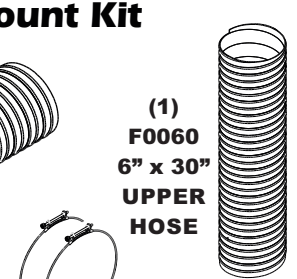
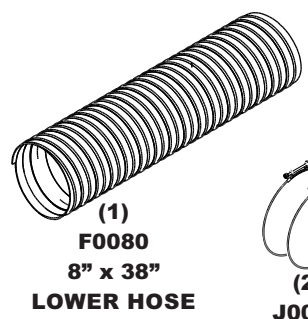

**A1890 Boot Kit**

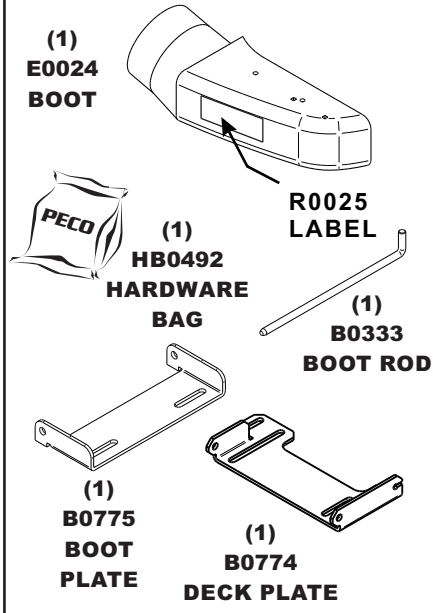

**A1879 Weight Kit**

