



Unit Model #: 37120903

Mower: Scag

Owner's Manual: Q0497

Mower Type: Liberty-Z

Engine Type: Kohler 7000 Series 22 HP

Deck Size: 48"

Vac Type: 9 Cu. Ft. Pro 2+ Bagger

Deck Type:

Drive Type: Rear PTO Drive (3-Blade)

Revision:

Fits Year(s): 2015

A1997 Vac Kit

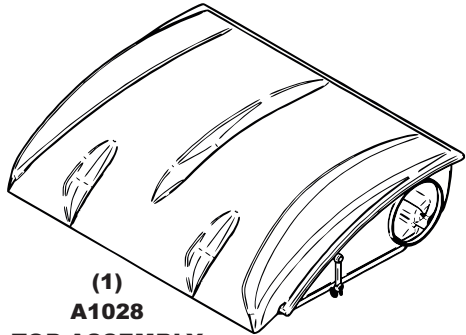

(1)
A1028
TOP ASSEMBLY



(1)
V0019
INLET

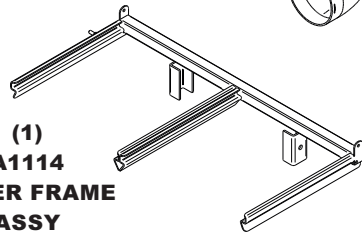

(1)
A1114
UPPER FRAME
ASSY



(1)
HB0622
HARDWARE
BAG

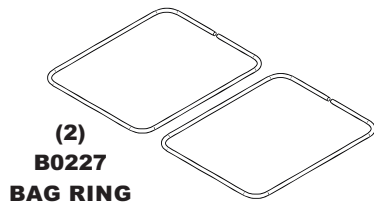

(2)
B0227
BAG RING

A1153 48" BAFFLE KIT



(1)
HB0476
HARDWARE
BAG



(1)
B0709
48" LEFT HAND
BAFFLE

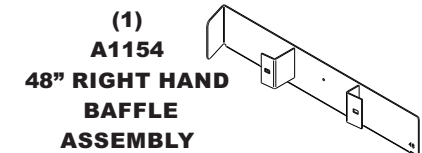

(1)
A1154
48" RIGHT HAND
BAFFLE
ASSEMBLY

A2029 Mount Kit

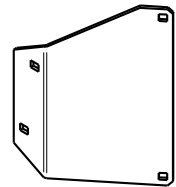

(1)
B0923
MOUNT PLATE
STIFFENER

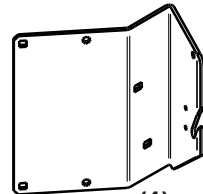

(1)
B0916
RIGHT PTO
MOUNT PLATE

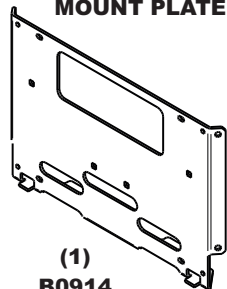

(1)
B0914
REAR
MOUNT
PLATE

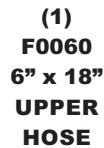

(1)
F0060
6" x 18"
UPPER
HOSE

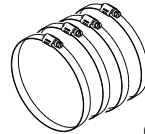

(4)
J0060
6"
HOSE
CLAMPS

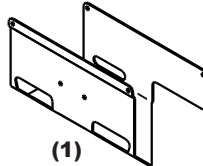

(1)
B0913
MUFLER
GUARD



(1)
B0917
LT. PTO
MNT. PL.

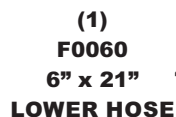

(1)
F0060
6" x 21"
LOWER HOSE

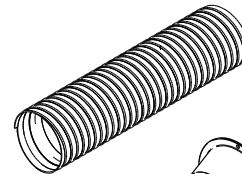

(1)
M0256
4L590DWK (A57K)
Kev. Cord Belt



(1)
V0016
BLOWER
CONE 6"

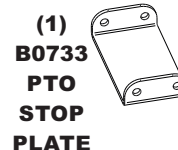

(1)
B0733
PTO
STOP
PLATE



(2)
G0002
3.3 CU. FT.
COLLECTION
BAGS

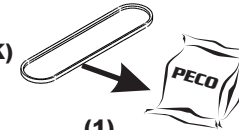

(1)
HB0651
ENGINE PULLEY
HARDWARE BAG

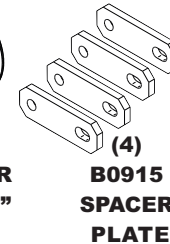

(4)
B0915
SPACER
PLATE



(1)
HB0652
HARDWARE
BAG

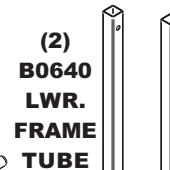

(2)
B0640
LWR.
FRAME
TUBE

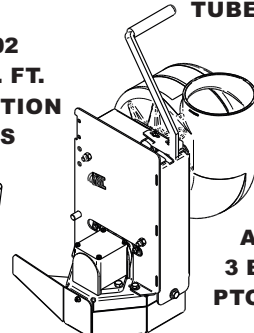

(1)
A2028
3 BLADE
PTO ASSY.

A1790 Boot Kit

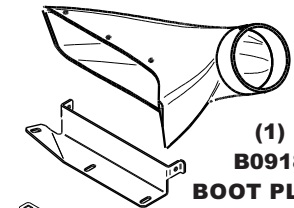

(1)
V0027
BOOT

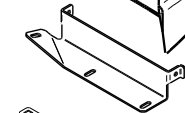

(1)
B0918
BOOT PLATE

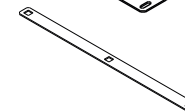

(1)
B0919
BOOT PLATE
FASTENER

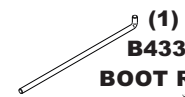

(1)
B4331
BOOT ROD



(1)
HB0432
HARDWARE
BAG

A1791 Weight Kit



(1)
HB0431
HARDWARE
BAG

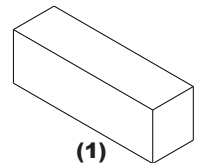

(1)
B0034
12" WEIGHT
BAR



(1)
B0576
WEIGHT
BRACKET