



# Unit Model #: 28120901

**Mower:** Kubota

**Owner's Manual:** Q0493

**Mower Type:** Kommander

**Engine Type:** Kohler 21 & 25 HP, Kawasaki 21.5

**Deck Size:** 48" & 54"

HP & Briggs and Stratton 22 & 25 HP

**Vac Type:** 9 Cu. Ft. Pro 2+ Bagger

**Drive Type:** Rear PTO Drive (3-Blade)

**Revision:** Initial Release 8/19/2015

**Fits Year(s):** 2015-2016

**A1997 Vac Kit**

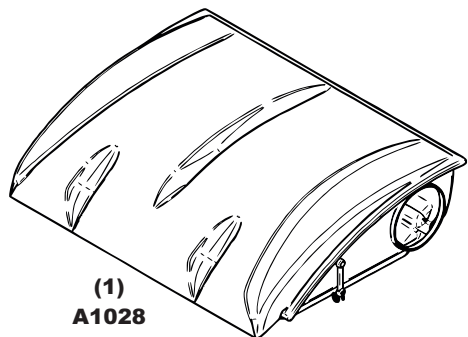

(1)  
A1028  
TOP ASSEMBLY



(1)  
V0019  
INLET

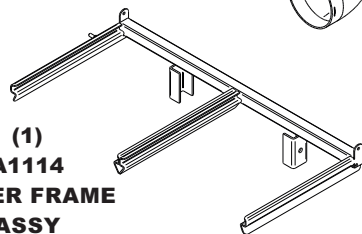

(1)  
A1114  
UPPER FRAME  
ASSY



(1)  
HB0622  
HARDWARE  
BAG

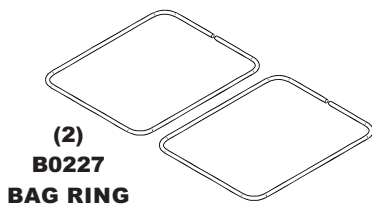

(2)  
B0227  
BAG RING

**A2031 BAFFLE KIT**

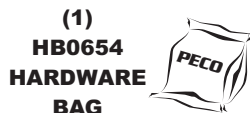

(1)  
HB0654  
HARDWARE  
BAG

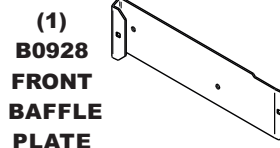

(1)  
B0928  
FRONT  
BAFFLE  
PLATE

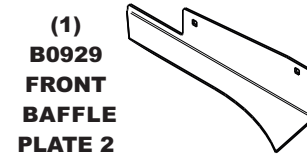

(1)  
B0929  
FRONT  
BAFFLE  
PLATE 2

**A2024 Mount Kit**

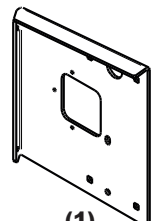

(1)  
B0905  
RIGHT  
FRAME PLATE

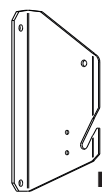

(1)  
B0904  
RIGHT PTO  
MOUNT PLATE

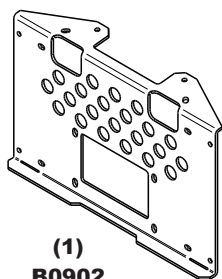

(1)  
B0902  
REAR  
MOUNT  
PLATE

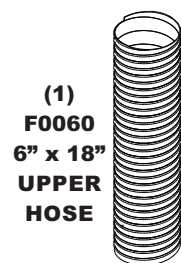

(1)  
F0060  
6" x 18"  
UPPER  
HOSE

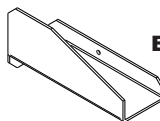

(1)  
C0072  
EXHAUST  
GUARD  
CAP

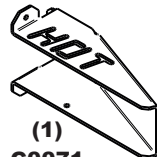

(1)  
C0071  
EXHAUST  
GUARD

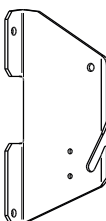

(1)  
B0903  
LT. PTO  
MNT. PL.



(1)  
F0060  
6" x 36"  
LOWER HOSE



(1)  
V0016  
BLOWER  
CONE 6"

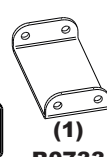

(1)  
B0733  
PTO  
STOP  
PLATE

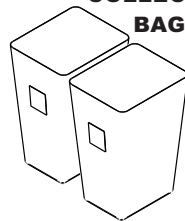

(2)  
G0002  
3.3 CU. FT.  
COLLECTION  
BAGS

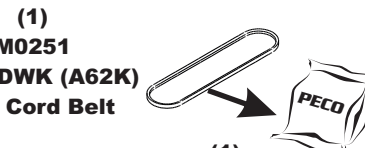

(1)  
M0251  
4L640DWK (A62K)  
Kev. Cord Belt



(1)  
HB0647  
ENGINE PULLEY  
HARDWARE BAG



(1)  
HB0649  
SAFETY  
HARDWARE BAG



(1)  
HB0646  
HARDWARE  
BAG



(4)  
J0060  
INTERLOCK  
KIT

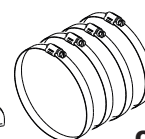

(2)  
B0939  
LWR.  
MOUNT  
TUBE

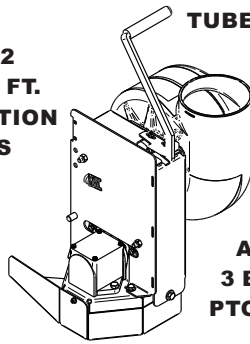

(1)  
A1842  
3 BLADE  
PTO ASSY.

**A 2025 Boot Kit**

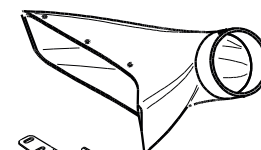

(1)  
V0048  
BOOT

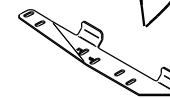

(1)  
B0906  
BOOT PLATE

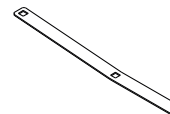

(1)  
B0910  
BOOT PLATE  
FASTENER



(1)  
HB0648  
HARDWARE  
BAG

**A2030 Weight Kit**



(1)  
HB0653  
HARDWARE  
BAG

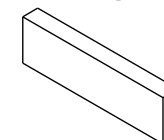

(1)  
B0704  
14" WEIGHT  
BAR



(1)  
B0941  
WEIGHT  
BRACKET