

MODEL#: 38621224

MOWER NAME: DIXIE CHOPPER

MOWER MODEL: XCALIBER SERIES

MOWER DECK SIZE: 66"

VAC NAME: PRO 12

6.5 HP BRIGGS & STRATTON VANGAURD ENGINE



FOR YEAR: 2009 - 2010

REVISED:

A1715 UNIT ASSEMBLY

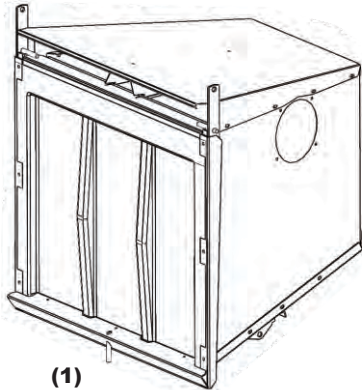

(1)
A0794
12 CU. FT. BOX
ASSEMBLY



(1)
V1054
6" PLASTIC
INLET



(1)
F0001
6" x 45"
UPPER
HOSE



(1)
F0010
9" x 36"
LOWER
HOSE

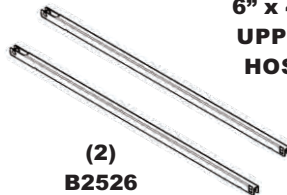

(2)
B2526
DOOR LINKAGE



(1)
A0273
BOX HANDLE

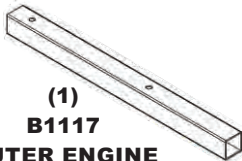

(1)
B1117
OUTER ENGINE
MNT. TUBE

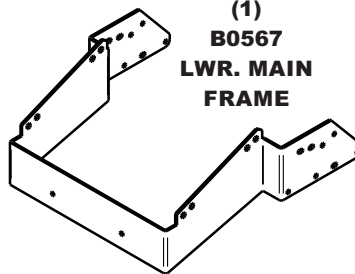

(1)
B0567
LWR. MAIN
FRAME

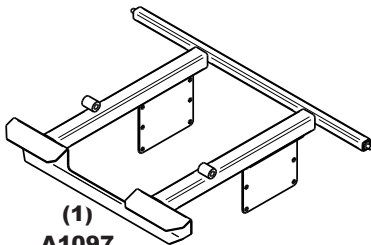

(1)
A1097
TOP MAIN
FRAME ASSY.

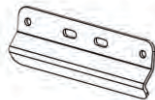

(1)
B0302
MAIN FRAME
CLAMP

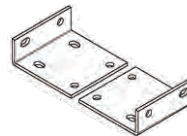

(2)
B0569
OUTER ENGINE
MNT. BRACKET

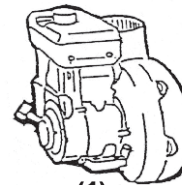

(1)
A639
ENGINE/
BLOWER/
BLADE ASSY.



(1)
E6020
9" BLOWER
CONE

A0619 THROTTLE KIT

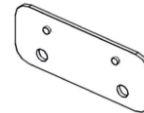

(1)
A0666
THROTTLE
MNT. PL.
ASSY.



(1)
A0060
70" THROTTLE
KIT
FOR (6.5 HP)



(1)
HB0249
HARDWARE
BAG

(2)
J0060
6" HOSE
CLAMPS



(2)
J0090
9" HOSE
CLAMPS



(1)
HB0386
HARDWARE
BAG

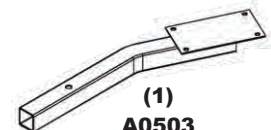

(1)
A0503
ENGINE MNT.
ARM ASSY.

A1711 - WEIGHT KIT

(1)
HB0382
HARDWARE
BAG

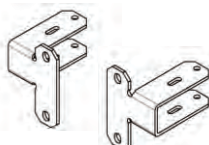

(2)
B0383
WEIGHT
BRACKET

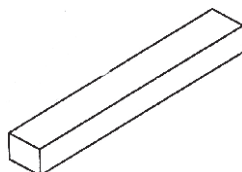

(1)
B2220
WEIGHT

A1713 - BOOT KIT

(1)
HB0383
HARDWARE
BAG



(1)
B1696
BOOT
PLATE

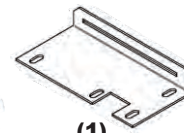

(1)
B1719
DECK MNT.
PLATE

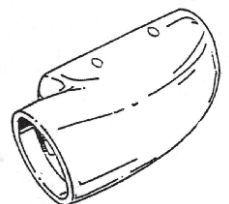

(1)
E2411
BOOT