

MODEL#: 35621228

MOWER NAME: EXMARK

MOWER MODEL: LAZER Z NEXT GENERATION

MOWER DECK SIZE: 48" 52" 60" & 72"

VAC NAME: 12 CUBIC FOOT BOX

6.5HP BRIGGS AND STRATTON VANGUARD

MANUAL: Q0384



FOR YEAR: 2009 - 2015

REVISED: 12/19/11

A1704 - UNIT ASSEMBLY

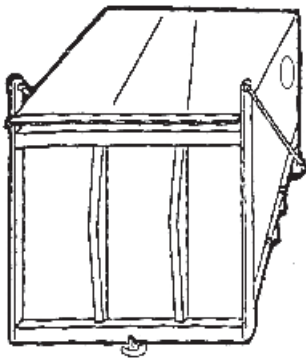

(1)
A0794
12 CU. FT. BOX
ASSEMBLY



(1)
V1054
INLET



(2)
J0060
6" HOSE
CLAMPS



(2)
J0080
8" HOSE
CLAMPS



(1)
HB0369
HARDWARE
BAG

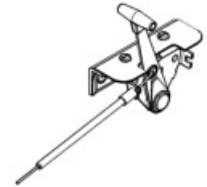

**A0060 - THROTTLE
CABLE KIT (70")**

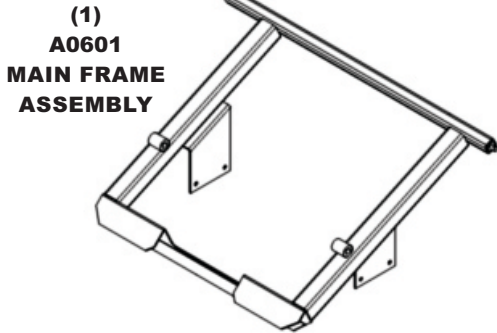

(1)
A0601
MAIN FRAME
ASSEMBLY

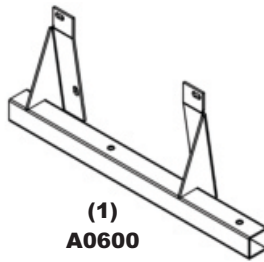

(1)
A0600
OUTER ENGINE
MOUNT TUBE
ASSEMBLY



(1)
6" x 31"
UPPER
HOSE



(1)
8" x 42"
LOWER
HOSE

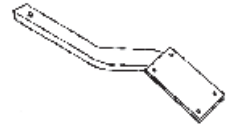

(1)
A0318
MOTOR MOUNT
ARM ASSY.



(2)
B2526
DOOR LINKAGE



(1)
A0273
BOX HANDLE

(1) B0529 LEFT &
(1) B0528 RIGHT
LOWER MAIN
FRAME LEGS



(1)
E6009
8" BLOWER
CONE

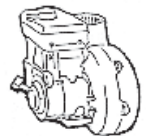

(1)
A639
ENGINE/BLOWER
BLADE ASSY.

A0641 - BOOT KIT

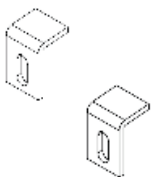

(2)
B0538
BOOT PLATE



(1)
HB0207
HARDWARE
BAG

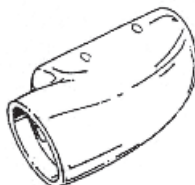

(1)
E1039
BOOT

A0665 - WEIGHT KIT

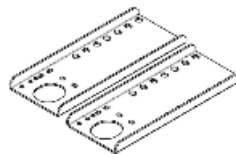

(2)
B0026
WEIGHT
BRACKETS

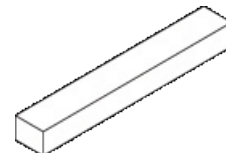

(1)
B2220
WEIGHT BAR



(1)
HB0370
HARDWARE
BAG