

MODEL#: 23621210

MOWER NAME: BOB-CAT

MOWER MODEL: ZT-200 SERIES (2007), PROCAT, PREDATOR PRO

MOWER DECK SIZE: 61", 52" & 48" DECK

VAC NAME: 12 CUBIC FOOT BOX

ENG: 900 SER. BR (9.00 GROSS TORQUE / 205 cc)

BILL OF MATERIAL: BOM0319

NOTE:

NOTE:



FOR YEAR: 2009 - 2007

REVISED: 5/7/2012

A0991 UNIT ASSY.

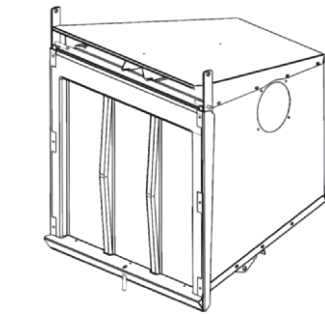

(1)
A0794
12 CU. FT.
BOX ASSY.



(1)
V1054
6" PLASTIC
INLET

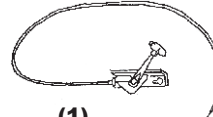

(1)
A0060
LONG THROTTLE KIT
FOR 900 SERIES



(2)
J0060
6" HOSE
CLAMPS



(2)
J0070
7" HOSE
CLAMPS



(1)
HB0332
HARDWARE
BAG

(1)
F0001
6" x 32"
UPPER
HOSE



(1)
F0004
7" x 48"
LOWER
HOSE

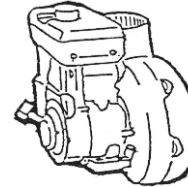

(1)
A638
ENGINE/
BLOWER/
BLADE ASSY.

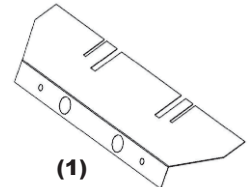

(1)
C0011
HEAT GUARD

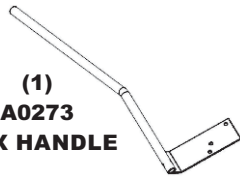

(1)
A0273
BOX HANDLE

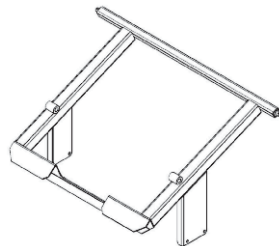

(1)
A0680
MAIN FRAME
ASSY.

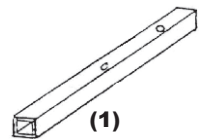

(1)
B1117
OUTER ENGINE
MOUNT TUBE

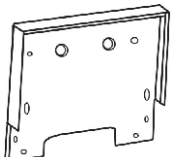

(1)
B0047
REAR MOUNT
PLATE



(1)
E6004
7" BLOWER
CONE

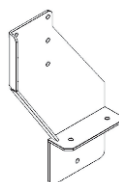

(1)
A0681
LT. LOWER
FRAME LEG
ASSY.

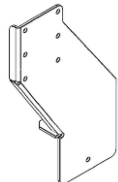

(1)
A0679
RT. LOWER
FRAME LEG
ASSY.

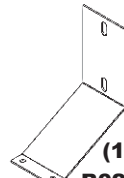

(1)
B0276
AIR CLEANER
MOUNT BRACE

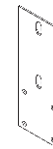

(1)
B0275
AIR CLEANER
MOUNT PLATE

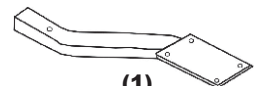

(1)
A0318
ENGINE MOUNT
ARM ASSY.

A0683 WEIGHT KIT



(1)
HB0120
HARDWARE
BAG

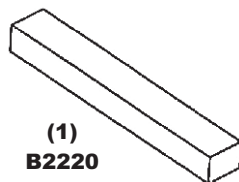

(1)
B2220
WEIGHT

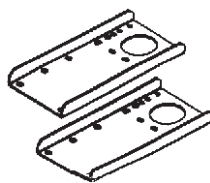

(2)
B0026
WEIGHT
BRACKET

A0908 BOOT KIT



(1)
HB0078
HARDWARE
BAG

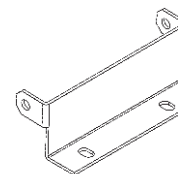

(1)
B0435
BOOT
PLATE

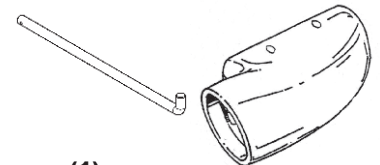

(1)
B0288
BOOT
ROD

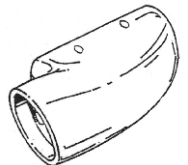

(1)
E1031
BOOT