

PTO GRASS COLLECTION SYSTEM



DESIGNED FOR THE ZT AND CZT SERIES MOWER

Model # 48120903



OPERATOR'S MANUAL

PART #: Q0486

ASSEMBLY • OPERATION • MAINTENANCE

RESIDENTIAL BAGGING SYSTEM

TABLE OF CONTENTS

SECTION	PAGE	SECTION	PAGE
Safety	2	2-13 Upper Hose Installation	11
Safety Alert Symbols	3	2-14 Lower Hose To Blower Cone Installation	11
Warranty	4	2-15 Lower Hose To Boot Installation	11
I INTRODUCTION AND DESCRIPTION	5	2-16 Installation/Removal Of Collection Bags	12
1-1 Introduction	5	PTO Drive System Packing List	13
1-2 Description	5	Exploded Parts View	14
II INSTALLATION FOR USE	5	Exploded Parts View Description	15
2-1 Preparation Of Mower	5	III OPERATING INSTRUCTIONS	16
2-2 Right Fame Mount Assy. Installation	5,6	3-1 General Safety	16
2-3 PTO Assembly Installation	6	3-2 Operation & Tips On Mowing	16
2-4 Belt Installation/Removal & Adjustment	6-8	3-3 Disengagement Of The PTO Assembly	16
2-5 Blower Cone Installation/Removal	8	3-4 Unloading The Collection System	16
2-6 Lower Frame Installation	8,9	IV MAINTENANCE	16
2-7 Exhaust Deflector Installation	9	4-1 Maintenance Checklist	16-17
2-8 Upper Frame Installation	9	4-2 Lubrication	17
2-9 Top Assembly. To Upper Frame Installation	9,10	V PARTS AND SERVICE	17
2-10 Inlet Installation	10	5-1 Parts And Service Information	17
2-11 Boot To Mower Deck Installation	10	Safety Decals	18
2-12 Length Of Hose Adjustment	11	Torque Specifications	19
		Notes	20

SAFETY

1. Read the operator's manual carefully and familiarize yourself with the proper use of your attachment. Do not allow anyone who is not acquainted with the Safety Instructions to use your attachment.
2. Know the controls and how to stop quickly. **READ THE OPERATOR'S MANUAL!**
3. Do not allow children to operate the vehicle. Do not allow adults to operate it without proper instruction.
4. Be especially watchful of children and pets darting into the area while operating.
5. Keep your eyes and mind on your unit while mowing or operating your attachment. Don't let others distract you.
6. Do not attempt to operate your unit or mower when not in the driver's seat.
7. Always stop unit when emptying the container.
8. Stop unit, shut off deck attachment, set parking brake, shut off mower engine and remove spark plug wire before removing clogs, removing or replacing hose, boot, blower cone, or performing any maintenance.
9. Mow across the face of slopes (not steeper than 10 degrees); never up and down the face.
10. It is recommended that the container be kept only half full when negotiating any slopes. Start mowing on slopes when the container is empty.
11. Inspect your lawn and remove any foreign objects before mowing. Never deliberately run the mower across any foreign object.
12. Wear hearing protection.
13. Wear eye protection to prevent debris from damaging your eyes.

SAFETY

WARNING! **NEVER** operate the mower unless the discharge guard and either the deflector assembly or the vacuum collector adapter are fastened securely in place.

WARNING! Do not work around the mower deck boot or the blower area until you are certain that the mower blades and the blower impeller have stopped rotating.

WARNING! To avoid serious injury, perform maintenance on the vacuum collector; **ONLY AFTER STOPPING THE MOWER'S ENGINE AND WAITING FOR ALL MOVING PARTS TO COME TO A COMPLETE STOP.** Set the parking brake. Always remove the ignition key before beginning maintenance.

WARNING! For your own personal safety, **ALWAYS** mow **ACROSS** the face of slopes and **NEVER UP and DOWN** the face. **NEVER** attempt to mow excessively steep slopes, and use caution when turning on any slope.

Safety Alert Symbol



This Safety Alert Symbol means: **“ATTENTION! BECOME ALERT! YOUR SAFETY IS INVOLVED!”**

This symbol is used to call attention to safety precautions that should be followed by the operator to avoid accidents. When you see this symbol, carefully read the message that follows and heed its advice. Failure to comply with safety precautions could result in death or serious bodily injury.

Safety Signs

The signal words **DANGER**, **WARNING**, and **CAUTION** are used on the equipment safety signs. These words are intended to alert the viewer to the existence and the degree of hazard seriousness.



White letters on **RED**

This signal word indicates a potentially hazardous situation which, if not avoided, will result in death or serious injury.



Black letters on **ORANGE**

This signal word indicates a potentially hazardous situation which, if not avoided, could result in death or serious injury.

It may also be used to alert against unsafe practices.



Black letters on **YELLOW**

This signal word indicates a potentially hazardous situation exist which, if not avoided, will result in minor or moderate injury.

It may also be used to alert against unsafe practices.

PECO LIMITED WARRANTY FOR NEW PRODUCTS

A. WHAT IS UNDER WARRANTY?

New PECO, Inc. (PECO) extends the following warranties to the original purchaser of each new PECO consumer product subject to the following limitations.

1. PRODUCT WARRANTY: Any part of any consumer product, which is defective in material or workmanship as delivered to the purchaser will be repaired or replaced, as PECO elects, without charge for parts or labor, if the defect appears within 12 months from the date of delivery of the product to the original purchaser.

ALL DEFECTIVE PARTS MUST BE RETURNED TO PECO FOR INSPECTION TO DETERMINE VALIDITY OF WARRANTY CLAIMS. Freight and mailing will be borne by the customer.

2. PARTS REPLACED DURING WARRANTY: Any new PECO part which is furnished in performance of this warranty and is defective in material or workmanship as delivered to the purchaser will be repaired or replaced, as PECO elects, without charge if the defect appears within 90 days from the date of installation of such part or before the expiration of the original warranty period, whichever is later.

B. SECURING WARRANTY ADJUSTMENTS.

Call PECO for Return Authorization. Damaged or broken parts other than engines or batteries, must be returned to New PECO, Inc. 100 Airport Road, Arden, NC 28704 before any warranty adjustment can be authorized. At the time of requesting warranty adjustment, the purchaser must present evidence of the date of delivery of the product. The purchaser shall pay any charge for the product to and from Arden, NC.

C. ITEMS NOT COVERED BY PECO WARRANTY.

Engines and batteries attached to PECO products are covered under a separate warranty by the respective manufacturer.

D. UNAPPROVED ALTERATION OR MODIFICATION.

All obligations of PECO under this warranty shall be terminated if products are altered or modified in ways not approved by PECO.

E. ACCIDENTS AND NORMAL MAINTENANCE.

The warranty covers only defective material and workmanship. It does not cover depreciation or damage caused by normal wear, accident, improper use or abuse of products. The cost of normal maintenance and normal replacement of service items such as belts, cutting blades, hoses, etc., which are not defective shall be paid for by the purchaser.

F. NO REPRESENTATIONS ADDITIONAL WARRANTIES, DISCLAIMER.

Neither PECO nor any company affiliated with it makes any warranties, representations or promises as to the quality of performance of its products other than those set forth herein. Except as described above, PECO makes no other warranties **AND SPECIFICALLY DISCLAIMS ANY AND ALL IMPLIED WARRANTIES OF FITNESS AND MERCHANTABILITY.**

G. ANY MACHINE USED FOR RENTAL PURPOSES ARE GUARANTEED FOR 45 DAYS FROM DATE OF ORIGINAL SALE ONLY.

H. REMEDIED EXCLUSIVE.

The only remedies the purchaser has in connection with the breach or performance of any warranty on PECO consumer products are set forth above. In no event will PECO be liable for special incidental or consequential damages.

1. NO SERVICE CENTER WARRANTY.

The selling Service Center makes no warranty on his own on any item warranted by PECO unless he delivers to purchaser a separate written warranty certificate specifically warranting the item. The dealer has no authority to make any representation or promise on behalf of PECO or to modify the terms of this warranty in any way.

Section I

INTRODUCTION & DESCRIPTION

1-1 Introduction

Your grass collection system has been designed to give you a low maintenance, simple, and effective way to collect the grass clippings from your mower. This manual is provided to give you the necessary instructions to properly mount and operate the collection system on your mower. Please read this manual thoroughly. Understand what each control is for and how to use it. Observe all safety decal precautions on the machine and noted throughout the manual.

NOTE: all references made to right, left, front, rear, top or bottom are as viewed from the normal operator's position on the mower.

1-2 Description

The grass collection system is designed for turf maintenance where there is a need to collect the grass clippings as the mower cuts the turf. It is also used for picking up leaves in pre-season and post-season clean-up.

The blower, mounted on the right side of the unit, uses a belt and gearbox system from the engine PTO shaft. Drive train protection comes through belt slippage. The blower draws grass clippings from the discharge area of the cutting deck back to the (2) - 2.9 cubic foot collection bags P#(G0004) at the rear portion of the mower frame. The operator can engage the blower with a spring-lock engagement handle on the right side of the unit. Once the bags are full with clippings, they can be released to make for easy dumping.

Section II

INSTALLATION FOR USE

2-1 Preparation Of Mower

Carefully open the shipping box. The grass collection system will have various parts located inside. Remove and sort all parts for easy identification. Verify all parts against the list on page 13 and 14. If parts are missing, please contact PECO Inc. at (800) 438-5823.

NOTE: Before each step of assembly it will help to study the exploded drawings on pages 13, 14, 15 and 16.

2-1 Continued...

From the underside of the engine, remove the bolt and bushing from the electric clutch assembly. Use a bungee cord or similar device to hold the clutch in place while the hardware is removed.

Replace the hardware removed with the engine pulley assembly number 1 P#(A0198). Fasten the engine pulley to the electric clutch assembly using (1) 7/16" hi-collar helical spring lock washer P#(K0140) and (1) 7/16"-20 x 3-3/4" HHCS P#(K0350). See Figure 2-1 for details.

The added pulley will power the collection system.
Torque the bolt to 55 ft./lbs.

Figure 2-1

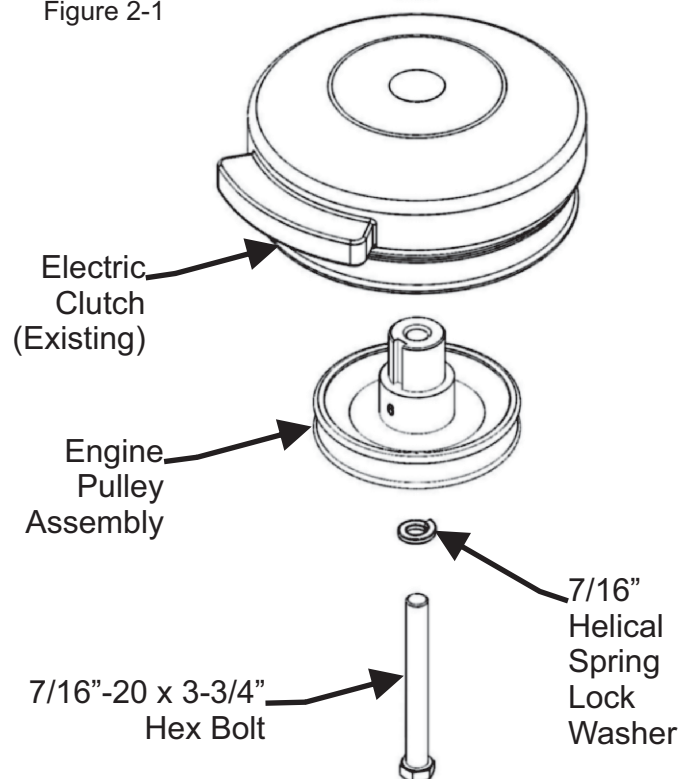

2-2 Right Frame Mount Assy. Installation

On the right side of the rear bumper plate, align the right frame mount assembly P#(A1023) to the (4) square holes in the rear bumper. See Figure 2-2a. Fasten the lower portion of the right frame mount assembly using (4) 5/16"-18 x 3/4" carriage bolts P#(K1142) and (4) 5/16"-18 flange nuts P#(K1178).

Clamp the top portion of the right frame mount assembly by positioning the clamp bracket P#(B0302) as shown in Figure 2-2b and fasten using (2) 3/8"-16 x 3/4" HHCS P#(K1190) and (2) 3/8"-16 flange nuts P#(K1215).

See next page for Figure 2-2a and Figure 2-2b.

2-2 Continued...

Figure 2-2a

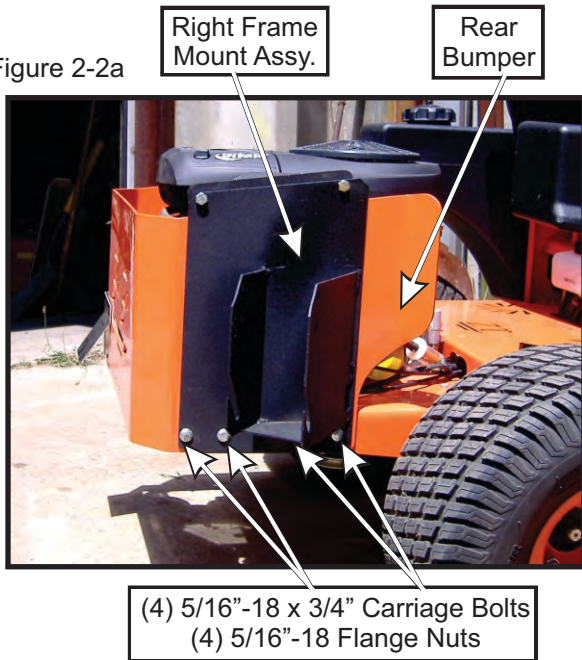
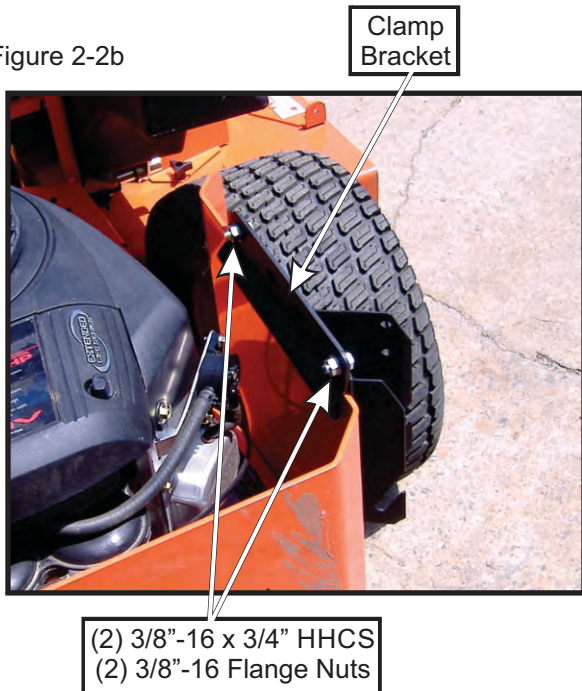

Figure 2-2b



2-3 PTO Assembly Installation

Insert the PTO arm mount rod P#(B0505) on the PTO assembly P#(A1840) into the mounting slots on the right frame mount assembly P#(A1023), as shown in Figure 2-3. You will secure the PTO assembly in Section 2-4, after the belt has been installed.

2-3 Continued...

Figure 2-3



2-4 Belt Installation/Removal and Adjustment

Remove (3) 1/4"-20 x 1/2" P#(K0353) HHSTS from the belt guard located on the bottom of the PTO assembly as shown in Figure 2-4a.

Figure 2-4a



2-4 Continued...

Loosen (4) 5/16"-18 x 3/4" HHCS P#(K1153) that secure the gearbox to the PTO assembly. Loosen the belt tension adjustment bolt: (1) 3/8"-16 x 2" HHCS P#(K1208). Refer to Figure 2-4b and 2-4c for reference.

Figure 2-4b

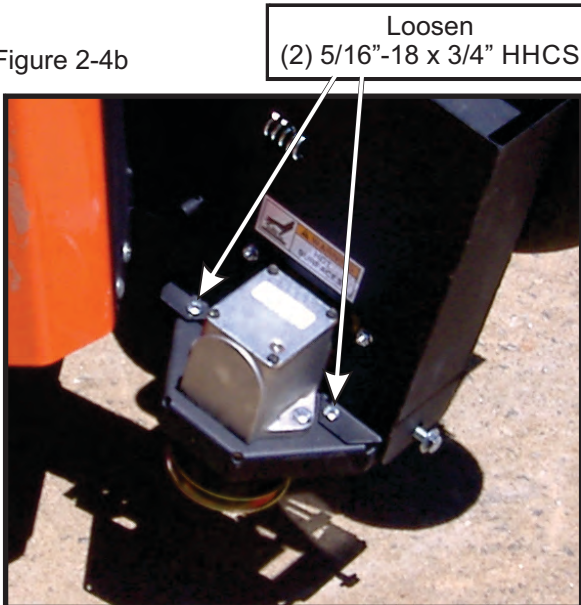
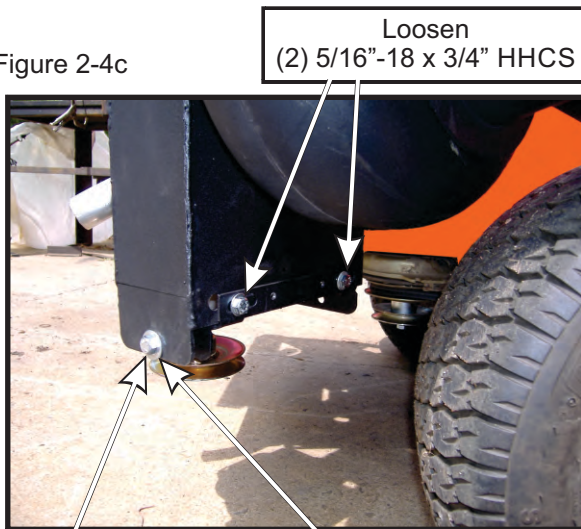

Figure 2-4c



Belt Tension Adjustment Bolt

Loosen (1) 3/8"-16 x 2" HHCS

After loosening the hardware in Figure 2-4b and 2-4c, slide the gearbox to the farthest left position (towards the engine). Wrap one end of the kevlar belt P#(M0247) around the engine pulley. Refer to Figure 2-4d. Next, wrap the other end of the kevlar belt around the pulley on the gearbox. Refer to Figure 2-4e.

2-4 Continued...

Figure 2-4d

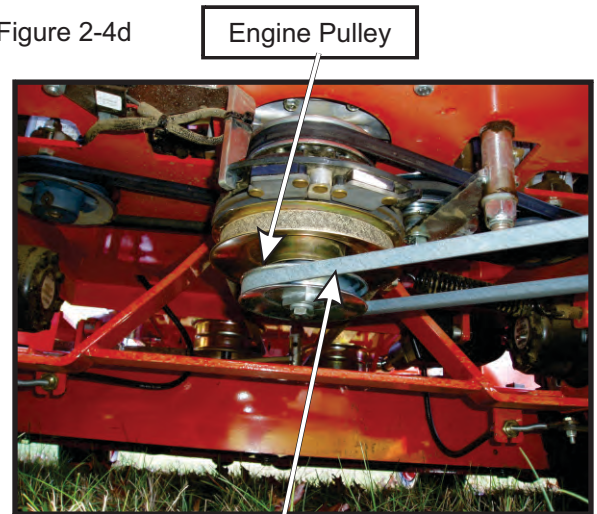
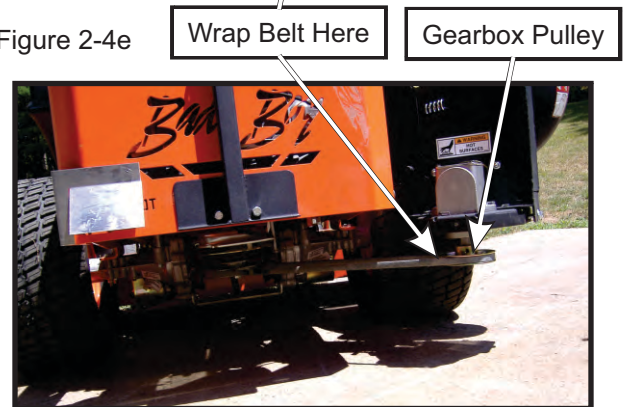
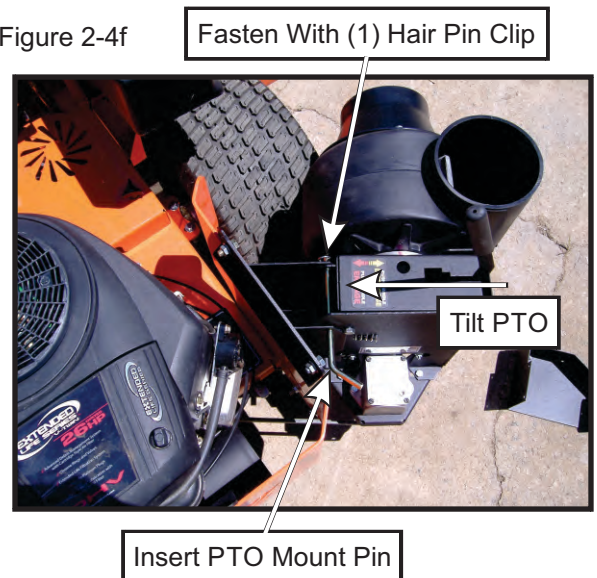

Figure 2-4e



With the kevlar belt wrapped around both pulleys, tilt the PTO assembly toward the engine, aligning the PTO mount pin holes on the PTO assembly with the mounting holes on the right frame mount assembly. Insert the PTO mount pin P#(B0274) in the mounting holes and fasten with (1) 1/8" x 2-3/8" hair pin clip P#(K0086). Refer to Figure 2-4f for reference.

Figure 2-4f



2-4 Continued...

To adjust the belt tension, turn the belt tension adjustment bolt (Figure 2-4c) clockwise until there is 1" of deflection with 10 -11 pounds of pressure applied to the center of the belt P#(M0247). When the belt has the proper tension, tighten the (4) 5/16"-18 x 3/4" HHCS P#(K1153) from Figure 2-4b and 2-4c that secure the gearbox to the PTO assembly. Replace the belt guard and (3) 1/4"-20 x 1/2" HHSTS P#(K0353).

2-10 Blower Cone Installation/Removal

Fasten the blower cone P#(V0016) to the blower housing located on the PTO assembly. Use (3) 1/4"-20 x 3/4" HHCS P#(K1222), (3) 1/4" lock washers P#(K0039), and (3) 1/4" flat washers P#(K0037) to secure the blower cone to the blower housing. Refer to Figure 2-5 for reference.

Figure 2-5

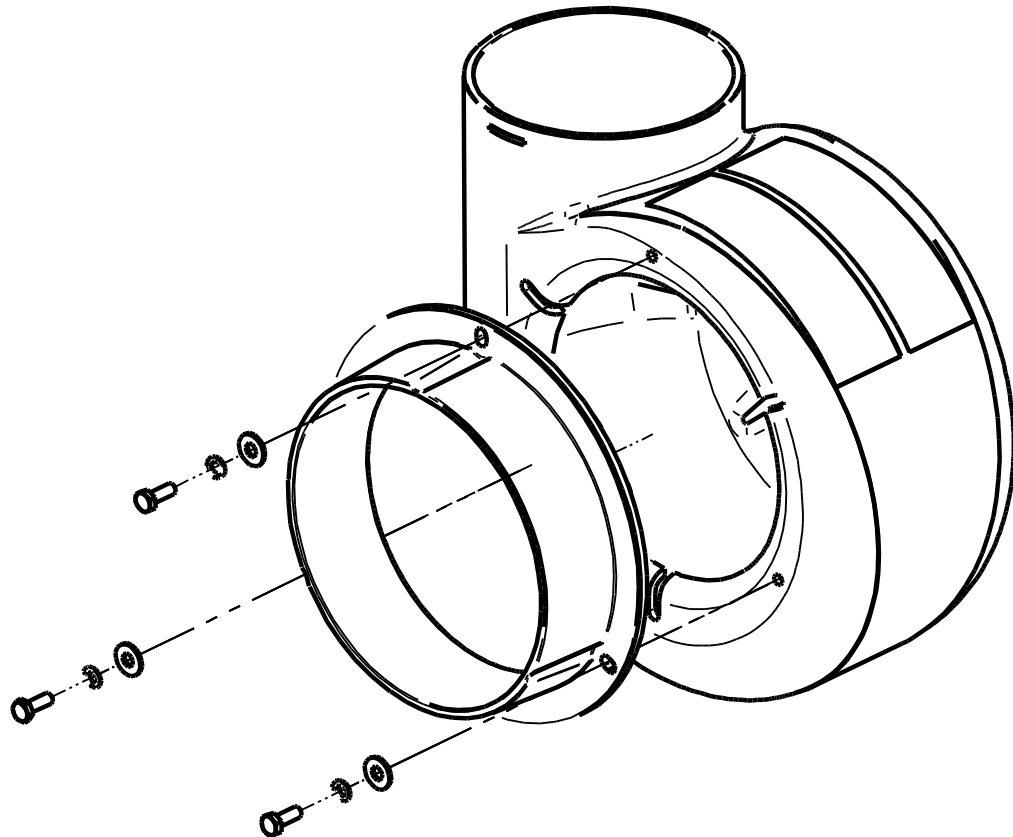

2-6 Lower Frame Installation

Place the lower frame assembly P#(A1022) to the rear bumper of the mower and align the holes. Fasten using (2) 3/8"-16 x 3/4" HHCS P#(K1190) and (2) 3/8"-16 flange nuts P#(K1215). Position the clamp bracket P#(B0302) as shown in Figure 2-7 and fasten to the lower frame assembly using (1) 5/16"-18 U-bolt P#(K1093) and (2) 5/16"-18 flange nuts P#(K1178). Make certain the bracket is clamping the lower frame assembly tight to the top portion of the mower's rear bumper. See next page...

2-6 Continued...

Figure 2-6

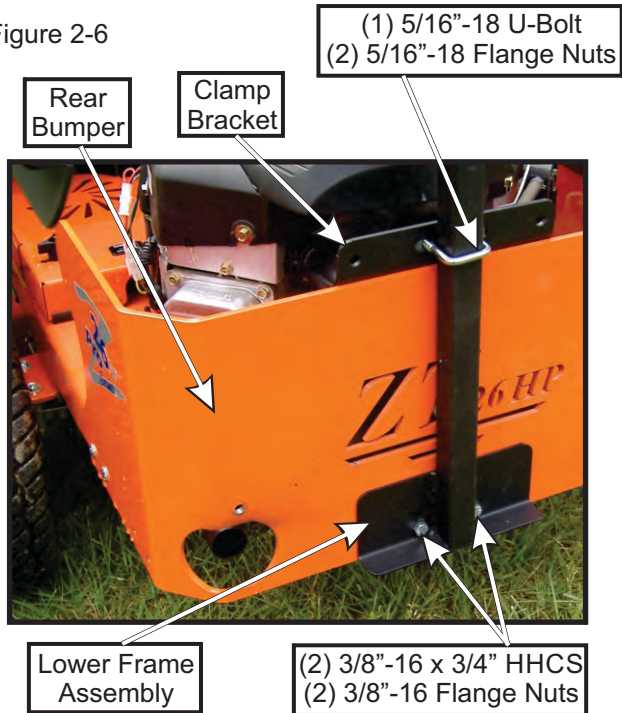

2-7 Exhaust Deflector Installation

For 26HP models, an exhaust deflector is required to prevent exhaust from blowing on the collection bags. Fasten the deflector P#(C0059) to the rear right side of the mower's bumper using (2) 5/16"-18 x 3/4" carriage bolts P#(K1142) and (2) 5/16"-18 flange nuts.

Figure 2-7

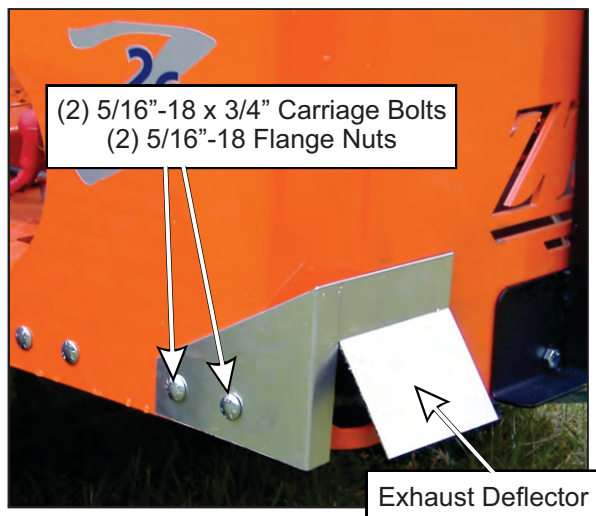

NOTE: For 27HP Kohler engines, an exhaust diverter P#(J0150) will also need to be added to the muffler.

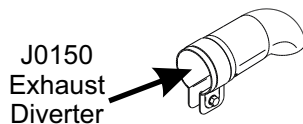

2-8 Upper Frame Installation

Slide the upper frame assembly P#(A0871) onto the vertical mount tube located on the lower mount assembly P#(A1022) as shown in Figure 2-8.

Figure 2-8

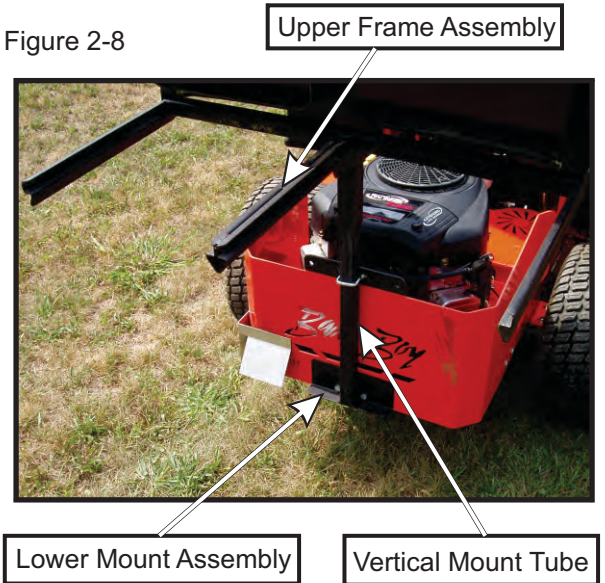

2-9 Top Assembly To Upper Frame Installation

Lift the top assembly P#(A1046) into position, as shown in Figure 2-9a. Fasten the top assembly to the upper frame assembly P#(A0871) using (2) 5/16"-18 x 2-1/2" tap bolt P#(K0125), (2) 1/4" flat washer P#(K0037), and (2) 5/16"-18 nyloc nut P#(K1180). When fastening, leave the nyloc nuts slightly loose to allow the top assembly to pivot freely.

Figure 2-9a

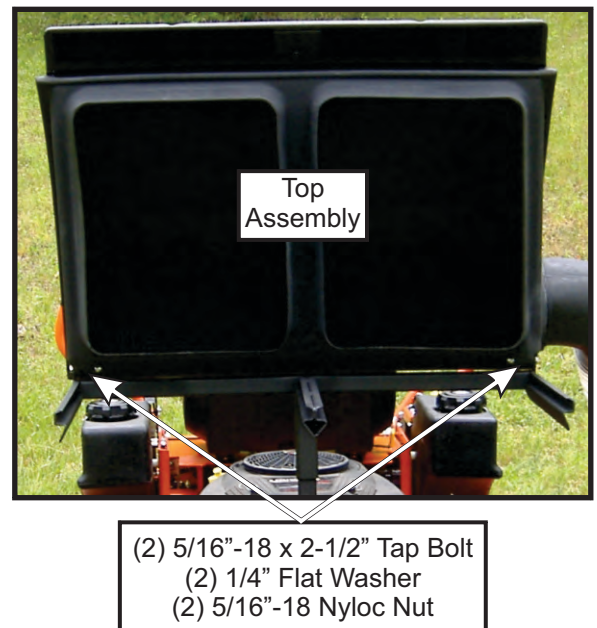

2-9 Continued...

Figure 2-9b shows a closer detail of the hardware location for mounting the top assembly to the upper frame assembly.

Figure 2-9b

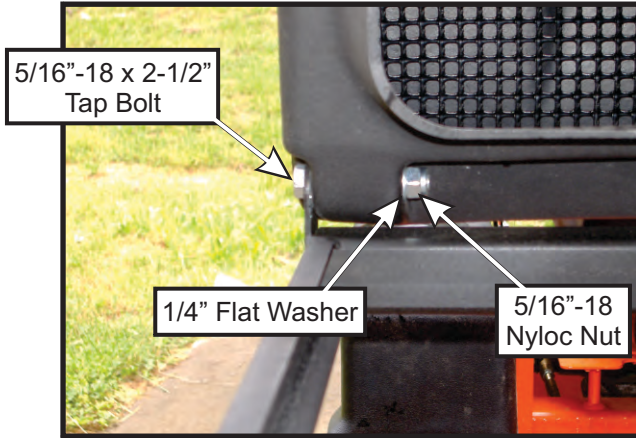

2-10 Inlet Installation

With the top assembly P#(A1046) in the upright position, insert the inlet P#(V0019) into the right hand hole in the top assembly as shown in Figure 2-10. Continue to insert the inlet until it snap locks into place. The inlet should now pivot freely about the hole.

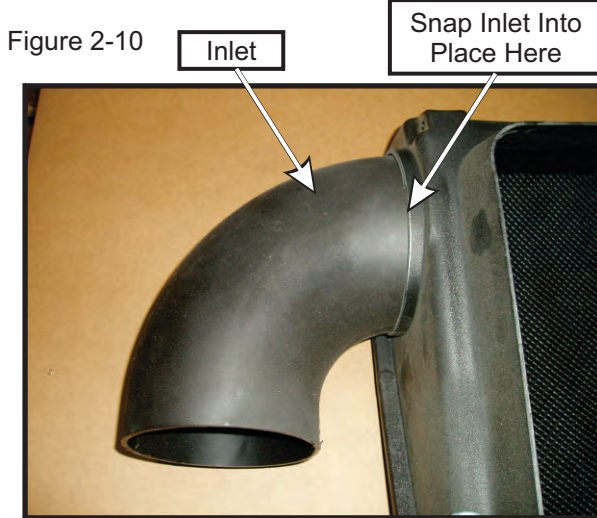

2-11 Boot To Mower Deck Installation

Remove the existing grass deflector from the mower deck. Fasten the boot plate P#(B0502) to the boot P#(V0020) using (3) 3/8"-16 x 1" carriage bolts P#(K1182) and (3) 3/8"-16 flange nuts P#(K1215) as shown in Figure 2-11a. Insert bolts from the inside of the boot so that the threads are on the top outside of the boot. This will help to prevent grass from collecting on the bolts.

2-11 Continued...

Figure 2-11a

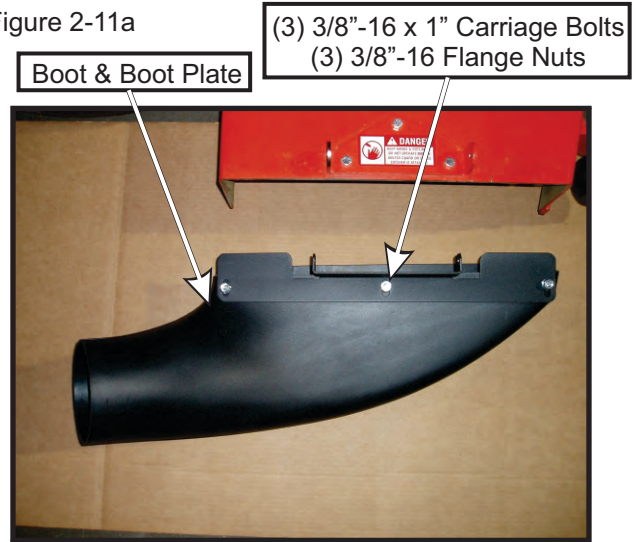

Position the boot and boot plate assembly as shown in Figure 2-11b for 60" deck models and as shown in Figure 2-11c for 50" deck models. Insert the boot rod P#(B0244) through the boot plate hole followed by the mower's deflector shield mount holes. Fasten the boot rod with (1) 3/32" x 2" hair pin clip P#(K0099).

Figure 2-11b
60" Deck Mounting

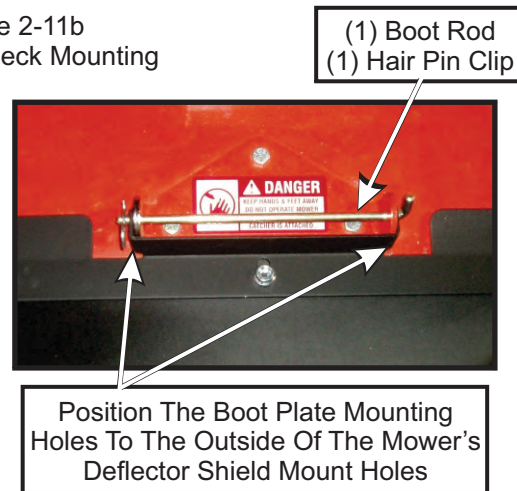
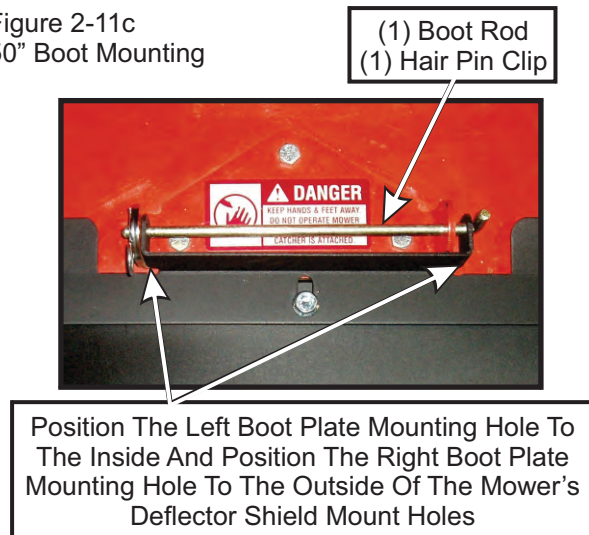

Figure 2-11c
50" Boot Mounting



2-12 Length Of Hose Adjustment

The hoses in steps 2-13 and 2-14 must be cut to fit your machine. Do not cut the hoses until you have tried to fit them on your machine. Remember that the hoses have to be long enough to adjust for the blower assembly's movement as well as allow for enough clamping surface between the inlet, blower assembly and the deck boot. Using a knife and wire cutters, cut the supplied 6" x 46" hose into (2) separate pieces, one measuring 18" long (upper hose) and the other 28" long (lower hose).

2-13 Upper Hose Installation

Slide a 6" hose clamp P#(J0060) over both ends of the 6" x 18" upper hose. Then slide one end of the upper hose onto the inlet. Make sure there is about a two-inch overlap between the hose end and the container inlet. Proceed to slide the opposite end of the upper hose onto the outlet of the blower assembly. See Figure 2-14 for details. Tighten the hose clamps.

2-14 Lower Hose To Blower Cone Installation

Slide a 6" upper hose clamp P#(J0060) over both ends of the 6" x 28" lower hose. Then proceed to slide the lower hose onto the blower cone. Tighten the hose clamp. See Figure 2-14 for details.

2-15 Lower Hose To Boot Installation

Take the unattached end of the 6" x 28" lower hose and slide it over the circular end of the boot. Use the 6" hose clamp P#(J0060) to secure the hose to the boot.

NOTE: Before tightening the hose clamp, rotate the lower hose counter clockwise (see Figure 2-14) approximately 1" and then tighten the clamp. This will hold the bottom edge of the boot tight to the mower deck.

Figure 2-14

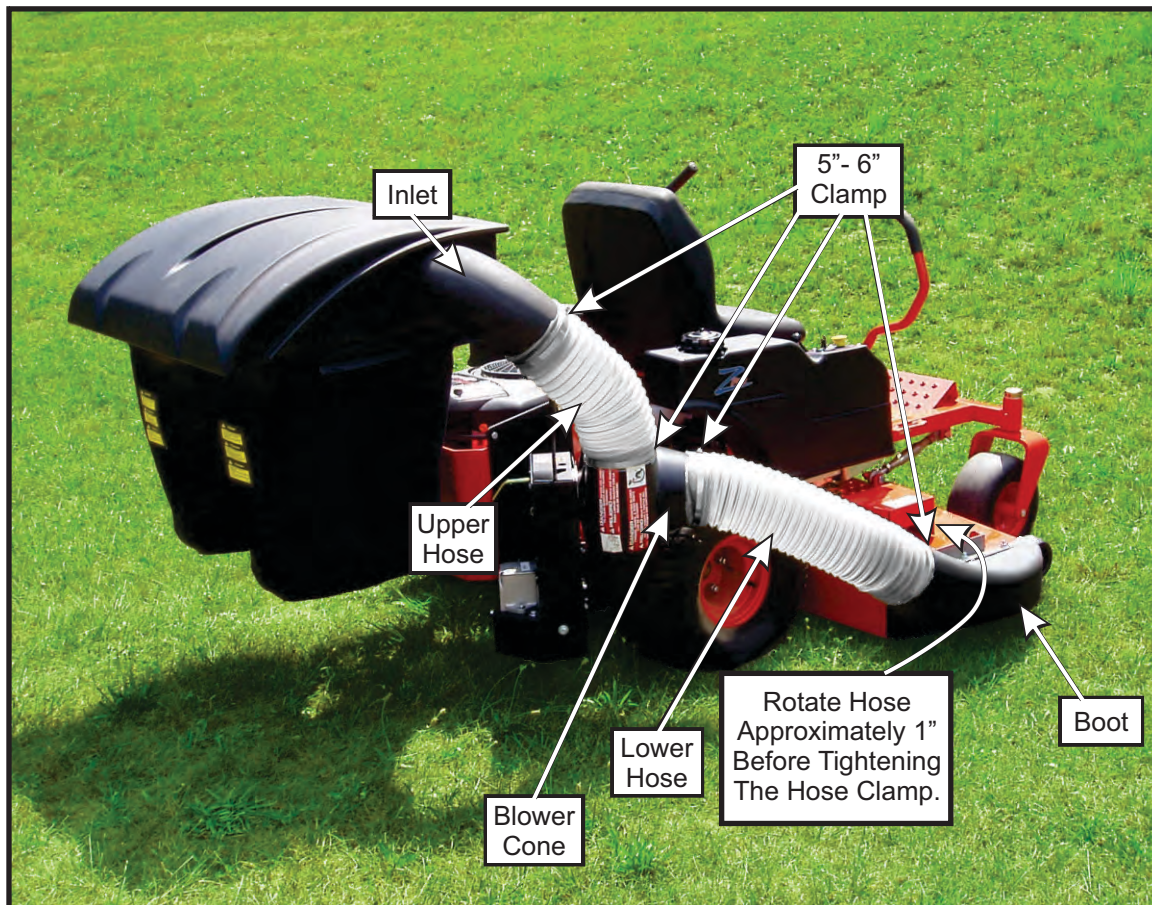

2-16 Installation/Removal Of Collection Bags

IMPORTANT!

To prevent bag wear, install (2) red plastic end caps P#(J0274), as shown in Figure 2-16a, on each bag ring before installing bags.

Figure 2-16a

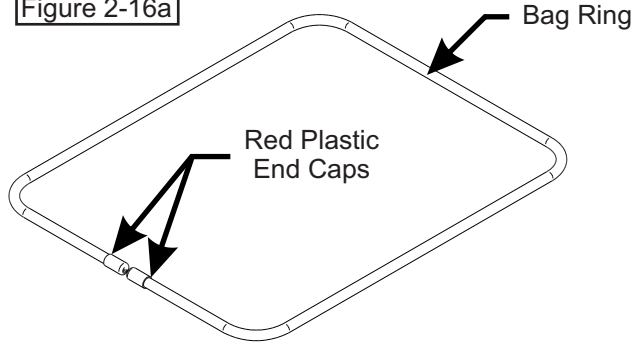

To install the bag onto the bag ring, place the seam openings of the bag onto the bag ring openings and turn the bag one full turn (360°) so the plastic end caps are located opposite to the opening in the bag (Figure 2-16b). Do this for each bag.

Figure 2-16b

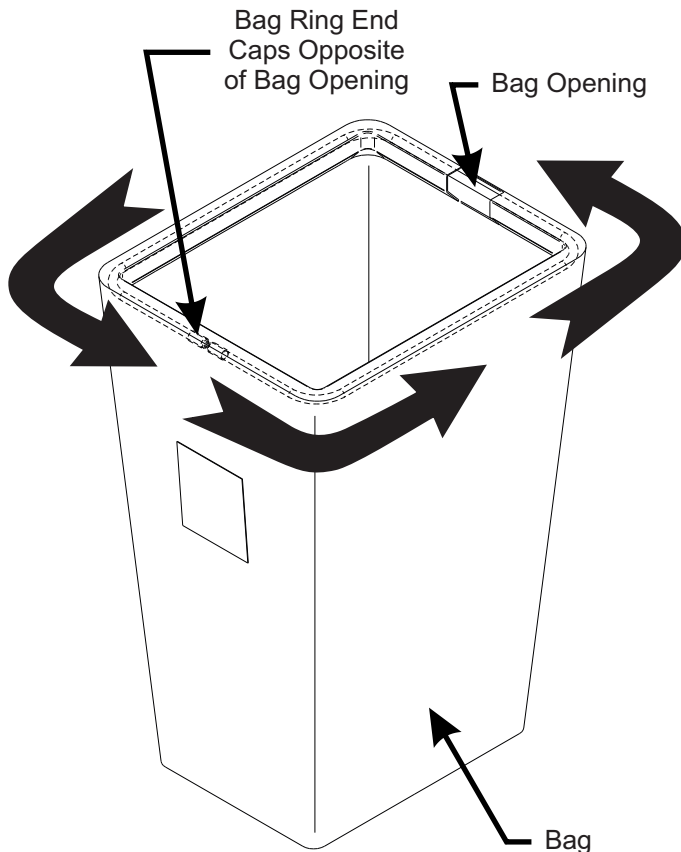

Install the completed assemblies onto the support frame and close the plastic top. Fasten the draw-latches to hold the plastic top closed (Figure 2-16c).

Figure 2-16c

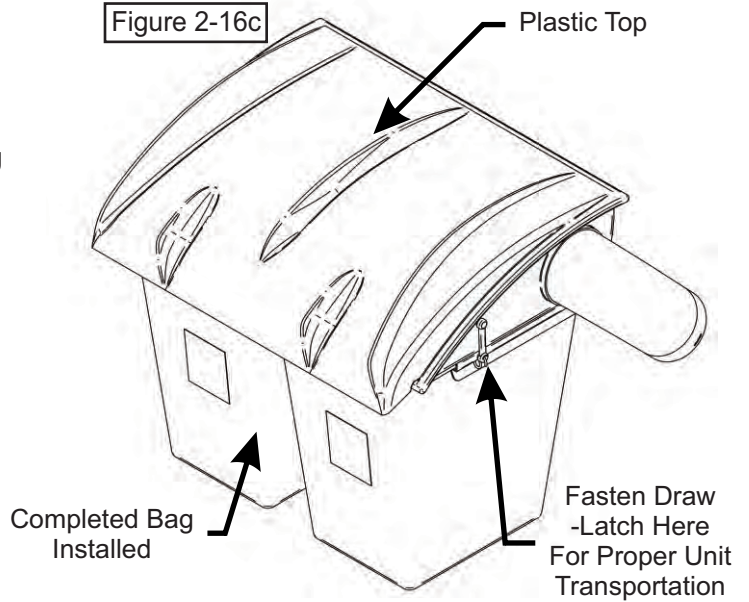

To empty the bag, first unlatch and lift top, next remove the bag and bag ring by sliding rearward, then grasp the loop on the bottom of the bag, and last turn it upside down to empty the collected debris (Figure 2-16d). Repeat for the other bag. Reinstall both bags, line with plastic bags if desired, close the plastic top and reattach the draw latches.

Figure 2-16d

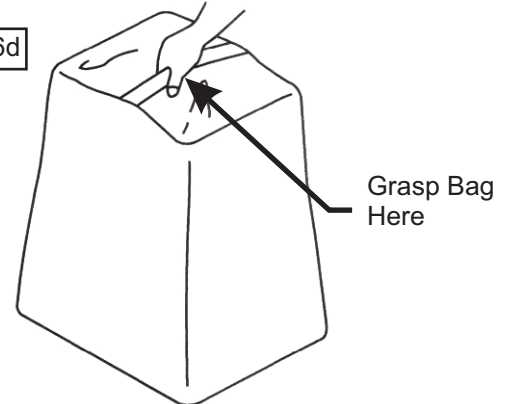

Plastic lawn and leaf bags, 33 gallon size, may be used inside the cloth bags. Be sure to leave enough plastic bag hanging over the frame so the plastic bags can be twist tied before emptying (Figure 2-16e).

Figure 2-16e

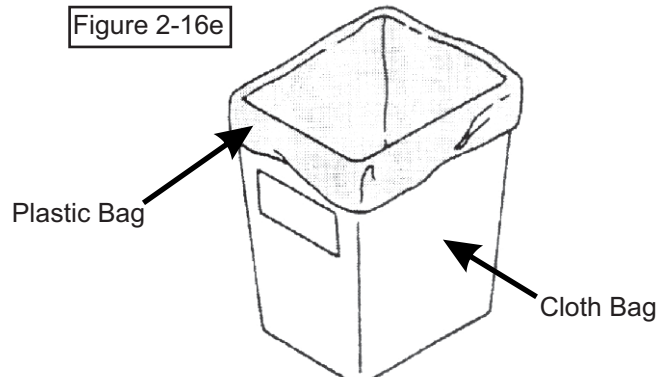

Unit Model #: 48120903

Mower & Type: Bad Boy ZI & CZT Series 50" & 60" Decks

Mower Models: ZI Series

CZT Series

Owner's Manual: Q0486

Revision #: Initial Release 4/28/2014

Vac/Drive Type: P2B+ (9 Cu. Ft.) PTO Driven

Fits Year(s): 2008-2014

A1995 Vac Kit

A1044 Boot Kit

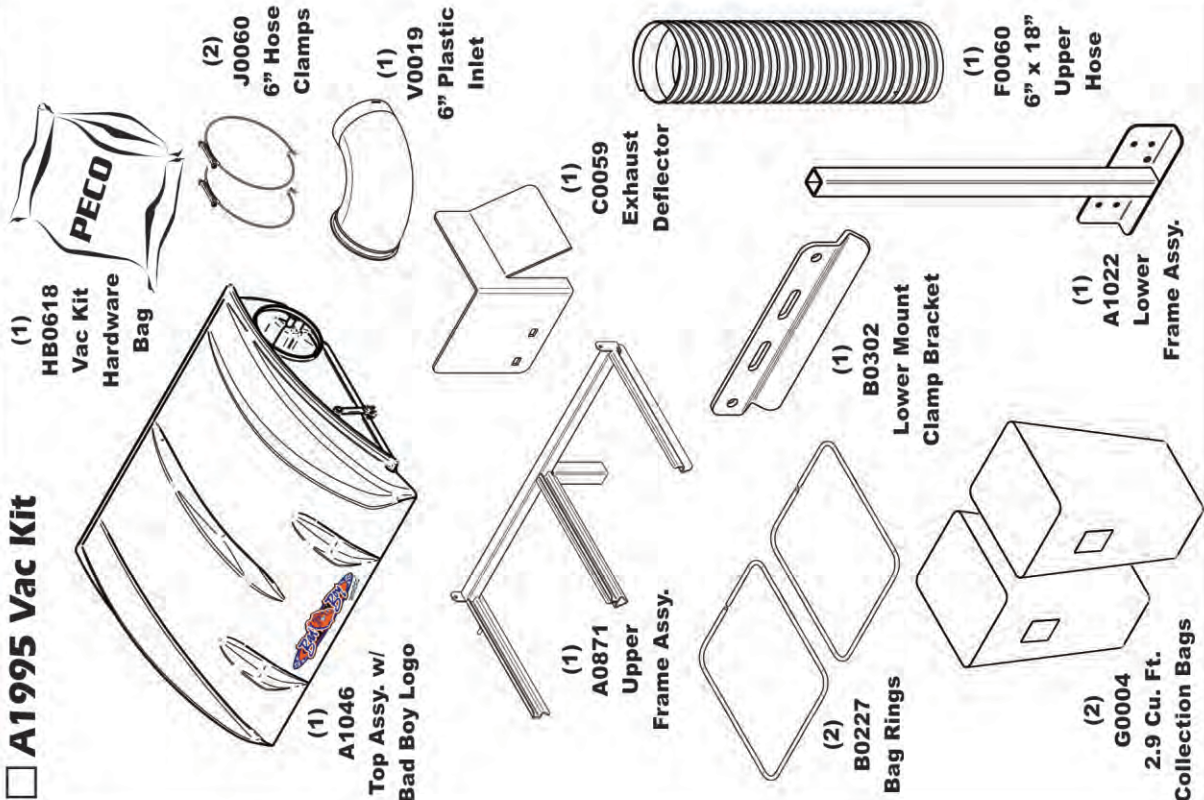
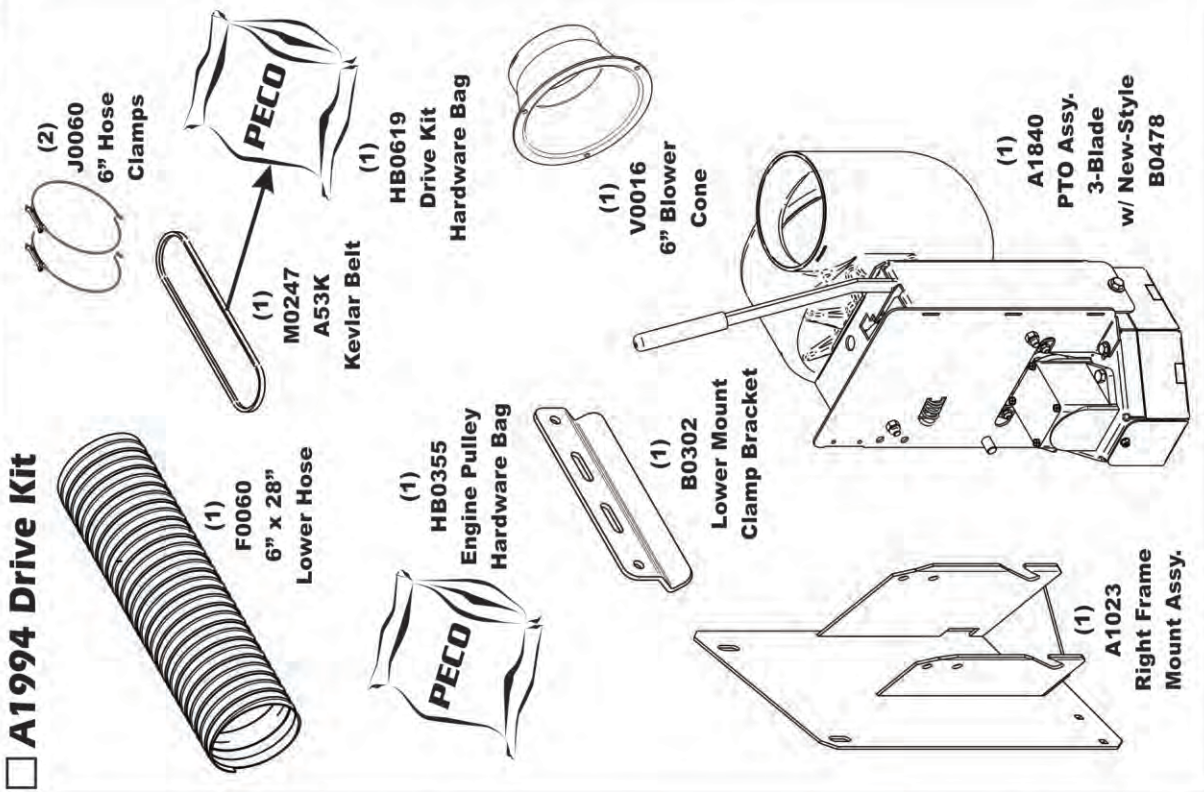

A1840 PTO ASSEMBLY EXPLODED PARTS VIEW DESCRIPTION

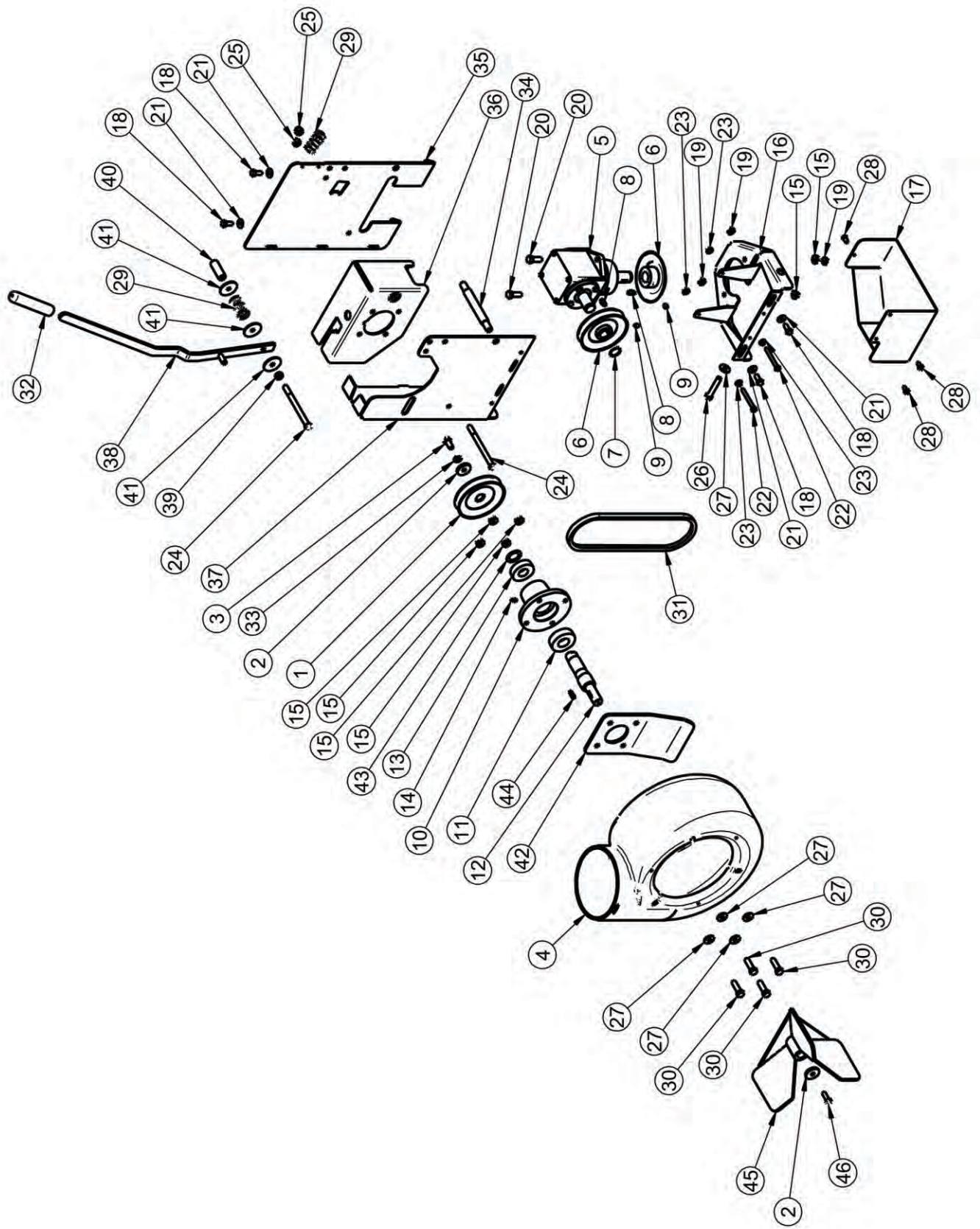

**A1840 PTO ASSEMBLY
EXPLODED PARTS VIEW**

Item #	Doc #	Title	Qty
1	M0266	'A' PULLEY FOR DECK DRIVE PTO	1
2	K1446	1.187 OD x .380 ID x .187 WASHER	2
3	k1190	3/8"-16 x 3/4" HHCS	1
4	V0015	BLOWER HSG.	1
5	A0431	GEAR BOX	1
6	A0498	PULLEY ASSY. FOR GEAR BOX	2
7	K0360	7/8" SNAP RING	2
8	J0272	#9 WOODRUFF KEY	2
9	K0035	5/16-18 SET SCREW	2
10	E0015	PTO SHAFT HOUSING	1
11	n0147	BEARING 2.0472 OD, 0.9843 ID, 0.5906 W (6205RS PEER)	1
12	B0460	PTO SHAFT	1
13	N0165	BEARING	1
14	J0801	1/4"-28 ZIRC FITTING	1
15	K1215	3/8"-16 FLANGE NUT	7
16	B0466	BASE PL.	1
17	B0478	GEAR BOX PULLEY GUARD	1
18	K1153	5/16"-18 x 3/4" HHCS	4
19	K1178	5/16"-18 FLANGE NUT	4
20	k1191	3/8"-16 x 1" HHCS	2
21	K0037	1/4" FLAT WASHER .75 OD x .314 ID x .060 T	4
22	k1150	1/4"-20 x 2-1/4" HHCS	2
23	K1126	1/4"-20 FLANGE NUT	4
24	K1202	3/8"-16 x 4-1/2" HHCS G5	2
25	k1216	3/8"-16 NYLOC NUT	2
26	K0348	3/8"-16 x 2" ALL THREAD HHCS	1
27	k0042	5/16" FLAT WASHER .875 OD x .380 ID x .075 T	5
28	K0353	1/4"-20 x 1/2" HHSTS	3
29	J0303	SPRING	2
30	K1192	3/8"-16 x 1-1/4" HHCS	4
31	M0267	A28K KEVLAR BELT	1
32	V1151	5/8" ID x 4-3/4" BLACK HANDLE GRIP	1
33	K0048	3/8" LOCK WASHER	1
34	B0505	PTO ARM MNT. ROD	1
35	B0506	LT. PTO ARM	1
36	B0642	BLWR. MNT. BRKT.	1
37	B0643	RT PTO ARM	1
38	A1112	PTO HANDLE ASSY	1
39	B0510	SPACER BUSHING	1
40	B0511	SPACER BUSHING	1
41	K0403	WASHER 1-1/2" OD x 3/8" ID	3
42	B0739	Blower Hsg. Stiffener Pl.	1
43	K0070	Flat Washer SS	1
44	J0254	3/16" x 3/16". x 3/4" Key	1
45	A1839	3-Blade Impeller Assy.	1
46	K1171	5/16"-24 LH x 7/8" HHCS GR. 5 w/ Patch Coating	1

SECTION III OPERATING INSTRUCTIONS

3-1 General Safety

Only qualified people familiar with this operator's manual and the mower's operator's manual should operate this machine.

3-2 Operation And Tips On Mowing

- A. Perform BEFORE EACH USE the maintenance list in paragraph 4-1.
- B. Start mower.
- C. With the mower at high idle speed, engage the mower deck.
- D. While seated in the operator's seat, pull the engagement handle of the PTO assembly towards the operator's seat until the handle slides into position in the retaining slot. With the PTO assembly engaged, you can proceed to operate the control levers of the mower.

NOTE: If the collection system does not appear to be collecting the grass clippings, disengage the deck and PTO assembly (Section 3-3), then, engage the parking brake and turn the mower off. Check upper and lower hoses for any clogs.

To obtain the maximum effectiveness from your collection system, the tips listed below should be followed:

- * Watch your speed- Normal conditions will allow a speed of up to approximately 4 mph, but thick, heavy damp conditions will require reduced ground speed.
- * Mow with sharp blades- A sharp blade cuts cleaner.
- * Wet grass and leaves will decrease effectiveness and will increase horsepower requirements.
- * Mow at higher cutting heights- Remove and mulch no more than 2" of grass length with each mowing. (Experts recommend not cutting off more than 1/3 of the grass blade length at any given time.)
- * Mow twice, at different height settings, (high, then low), if grass is extra tall.
- * Remember that horsepower requirements will vary with the mowing conditions such as type and height of turf grass, moisture content, amount of leaves, whether the terrain is flat or hilly, etc.

3-3 Disengagement Of The PTO Assembly

- A. To disengage the PTO assembly, slide the engagement handle out of the retaining slot and push the engagement handle away from the operator's seat.

WARNING: The PTO assembly blades will continue to spin. DO NOT TOUCH the PTO assembly, pulleys, or the belt until the tractor is turned off. DO NOT adjust the belt tension until the mower is turned off. Refer to section 2-6 of the manual.

3-4 Unloading The Collection System

NOTE: To determine when the collection bags are full, follow the following steps:

- A. Stop the forward movement of the mower.
- B. Disengage the mower deck.
- C. Disengage the PTO assembly.
- D. Engage the parking brake.
- E. Once the parking brake has been engaged, then and only then, walk behind the mower and check the collection bags by first unhooking the rubber strap with S-hook that secures the plastic top, then lift the plastic hood. Load in bags should not exceed the height of the installed bag.
- F. To remove the bags from the frame, slide bags out and turn bags over to deposit clippings.
- G. Slide empty bags back onto the frame and secure plastic top with the rubber strap with S-hook.

NOTE: Do not allow collection bags to become over-filled as potential damage may occur to your equipment. Also, be sure to clean the hood screen as needed.

SECTION IV MAINTENANCE

4-1 Maintenance Checklist

Before each use:

1. Check blades and spindles to be sure that no foreign objects, such as wire or steel strapping bands, are wrapped around them.
2. Inspect blades for wear. Replace if necessary. If it is necessary to sharpen the blades, remove the blades from the spindles before sharpening. DO NOT sharpen blades while still attached to the mower.

3. Make sure all shields are in place and in good condition. Repair or replace any missing or damaged shields.
4. Perform lubrication per paragraph 4-2.
5. Listen for abnormal sounds, which might indicate loose parts, damaged bearings, or other damage. Correct any deficiency before continuing operation.
6. With the engine off, engage the blower assembly. Check the belt tension and inspect the pulley belt for cracks or tears.
7. Check for wear or deterioration of the upper or lower hoses. If there are any portions of the hose that have been torn or worn through, replace immediately.

After Each Use:

1. Clean all debris from machine especially from the container, underneath the belt shields, and safety decals. Replace any missing or illegible decals.
2. Inspect the unit for worn or damaged components. Repair or replace before the next use. Any replacement component installed during repair shall include the component's current safety decal specified by the manufacturers to be affixed to the component.
3. Check belt for proper tension.

4-2 Lubrication

NOTE: Use only white lithium based grease for lubrication of the shaft on the blower assembly.

1. On initial use: Grease the fitting on the blower shaft.
2. Every 25 hours of use: Re-grease the grease fitting.
3. Every 200 hours of use: Check oil levels in gear box. Oil in gear box should cover the gears. If not, fill using an EP90 weight oil. 6oz. will fill the gear box from empty.

SECTION V PARTS AND SERVICE

5-1 Parts And Service Information

Collection system owners should record the name and telephone number of their Service Center. Your Service Center will be happy to supply replacement parts, accessories, and do any service or repairs to your collection system. If for any reason your Service Center is unable to service your collection system or supply replacement parts, contact PECO Inc. and include the following information on the chart below.

THE SERIAL NUMBER PLATE
IS LOCATED ON THE TOP
ASSEMBLY P#(A1046)



WRITE THE MODEL AND
SERIAL NUMBER IN THE
BOX TO THE LEFT
FOR FUTURE REFERENCE.

Unit Model Number: _____
Unit Engine Size: _____
Unit Serial Number: _____
Date of purchase: ____/____/_____
Dealer/Distributor Name: _____
Address: _____ **State:** _____ **Zip:** _____
Phone Number: _____

PECO Inc.
100 Airport Road | Arden, NC | 28704
Phone: 1-800-438-5823
Fax: (828)684-0858
E-Mail: peco@lawnvac.com

SAFETY DECALS

To promote safe operation, PECO Inc. supplies safety decals on all products manufactured. Damage can occur to safety decals either through shipment, use or reconditioning. Contact your local Service Center for replacement decals.



Part #: R1102
Bad Boy Logo



Part #: R2007
Never Use Hands Label

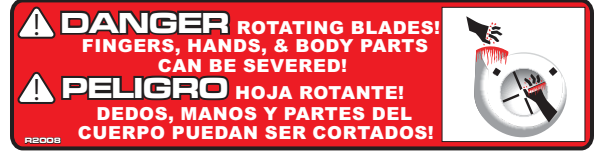

Part #: R2008
Rotating Blades Label



Part #: R1100
Engage-Disengage Label



Part #: R4037
Warning: Hot Surface Label



Part #: R1052
Small Warning: Turn Off Blower Label



Part #: R1065
Made In America Label

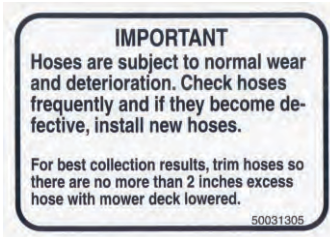

Part #: R1054
Important Label



Part #: R1069
Warning: Turn Off Blower Label



Part #: R1051
Warning: Hearing Protection Label



Part #: R4015
Danger: Rotating Blades Label

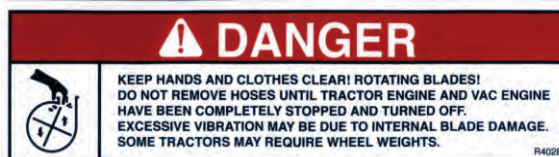

Part #: R4028
Danger Keep Hands & Clothes Clear Label



Part #: R4008
Caution: Rotating Blades Label

TORQUE SPECIFICATIONS

AMERICAN Bolt Head Markings

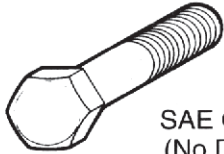

SAE Grade 2
(No Dashes)

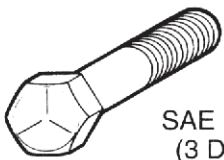

SAE Grade 5
(3 Dashes)

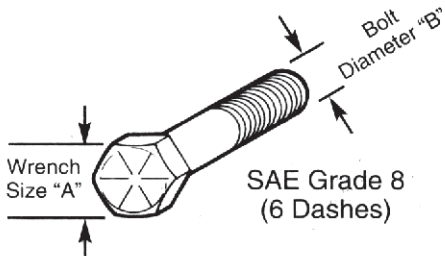

SAE Grade 8
(6 Dashes)

Recommended Torque in Foot Pounds (Newton Meters).*

WRENCH SIZE (IN.) "A"	BOLT DIAMETER (IN.) "B" AND THREAD SIZE	SAE GRADE 2	SAE GRADE 5	SAE GRADE 8
7/16	1/4 - 20 UNC	6 (7)	8 (11)	12 (16)
7/16	1/4 - 28 UNF	6 (8)	10 (13)	14 (18)
1/2	5/16 - 18 UNC	11 (15)	17 (23)	25 (33)
1/2	5/16 - 24 UNF	13 (17)	19 (26)	27 (37)
9/16	3/8 - 16 UNC	20 (27)	31 (42)	44 (60)
9/16	3/8 - 24 UNF	23 (31)	35 (47)	49 (66)
5/8	7/16 - 14 UNC	32 (43)	49 (66)	70 (95)
5/8	7/16 - 20 UNF	36 (49)	55 (75)	78 (106)
3/4	1/2 - 13 UNC	49 (66)	76 (103)	106 (144)
3/4	1/2 - 20 UNF	55 (75)	85 (115)	120 (163)
7/8	9/16 - 12 UNC	70 (95)	109 (148)	153 (207)
7/8	9/16 - 18 UNF	79 (107)	122 (165)	172 (233)
15/16	5/8 - 11 UNC	97 (131)	150 (203)	212 (287)
15/16	5/8 - 18 UNF	110 (149)	170 (230)	240 (325)
1-1/8	3/4 - 10 UNC	144 (195)	266 (360)	376 (509)
1-1/8	3/4 - 16 UNF	192 (260)	297 (402)	420 (569)
1-5/16	7/8 - 9 UNC	166 (225)	430 (583)	606 (821)
1-5/16	7/8 - 14 UNF	184 (249)	474 (642)	668 (905)
1-1/2	1 - 8 UNC	250 (339)	644 (873)	909 (1232)
1-1/2	1 - 12 UNF	274 (371)	705 (955)	995 (1348)
1-1/2	1 - 14 UNF	280 (379)	721 (977)	1019 (1381)
1-11/16	1-1/8 - 7 UNC	354 (480)	795 (1077)	1288(1745)
1-11/16	1-1/8 - 12 UNF	397 (538)	890 (1206)	1444 (1957)
1-7/8	1-1/4 - 7 UNC	500 (678)	1120 (1518)	1817 (2462)
1-7/8	1-1/4 - 12 UNF	553 (749)	1241 (1682)	2013 (2728)
2-1/16	1-3/8 - 6 UNC	655 (887)	1470 (1992)	2382 (3228)
2-1/16	1-3/8 - 12 UNF	746 (1011)	1672 (2266)	2712 (3675)
2-1/4	1-1/2 - 6 UNC	870 (1179)	1950 (2642)	3161 (4283)
2-1/4	1-1/2 - 12 UNF	979 (1327)	2194 (2973)	3557 (4820)

METRIC

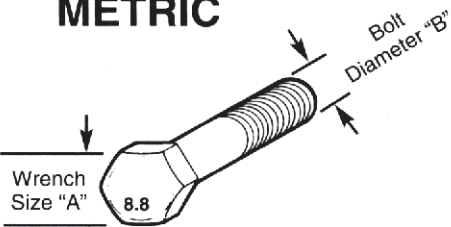

Numbers appearing on bolt heads indicate ASTM class.

Recommended torque in foot pounds (newton Meters).*

WRENCH SIZE (mm) "A"	BOLT DIA. (mm) "B"	ASTM 4.6	ASTM 8.8	ASTM 9.8	ASTM 10.9
8	5	1.8 (2.4)		5.1 (6.9)	6.5 (8.8)
10	6	3 (4)		8.7 (12)	11.1 (15)
13	8	7.3 (10)		21.1 (29)	27 (37)
16	10	14.5 (20)		42 (57)	53 (72)
18	12	25 (34)	74 (100)	73 (99)	93 (126)
21	14	40 (54)	118 (160)	116 (157)	148 (201)
24	16	62 (84)	167 (226)	181 (245)	230 (312)
30	20	122 (165)	325 (440)		449 (608)
33	22		443 (600)		611 (828)
36	24	211 (286)	563 (763)		778 (1054)
41	27		821 (1112)		1138 (1542)
46	30	418 (566)	1119 (1516)		1547 (2096)

*Use 75% of the specified torque value for plated fasteners. Use 85% of the specified torque values for lubricated fasteners.

NOTES



Bad Boy Mowers

Phone: (866) 622-3269

Website: www.badboymowers.com