



Unit Model #: 56131503

Mower: Spartan

Owner's Manual: Q0563

Mower Type: RT-Pro, RT-HD, SRT-XDe & SRT-XD

Deck Size: 72"

Vac Type: P3B (15 Cu. Ft.)

Deck Type:

Drive Type: PTO-X Driven

Revision #: 0

Fits Year(s): 2018 & Newer

A2311 Vac Kit

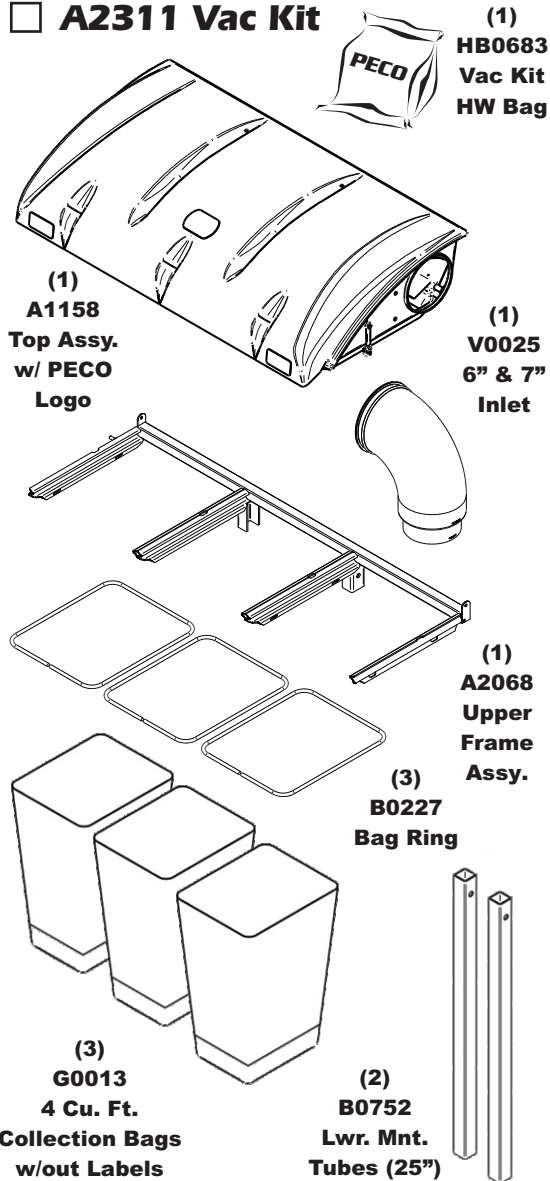

A2317 Mount Kit

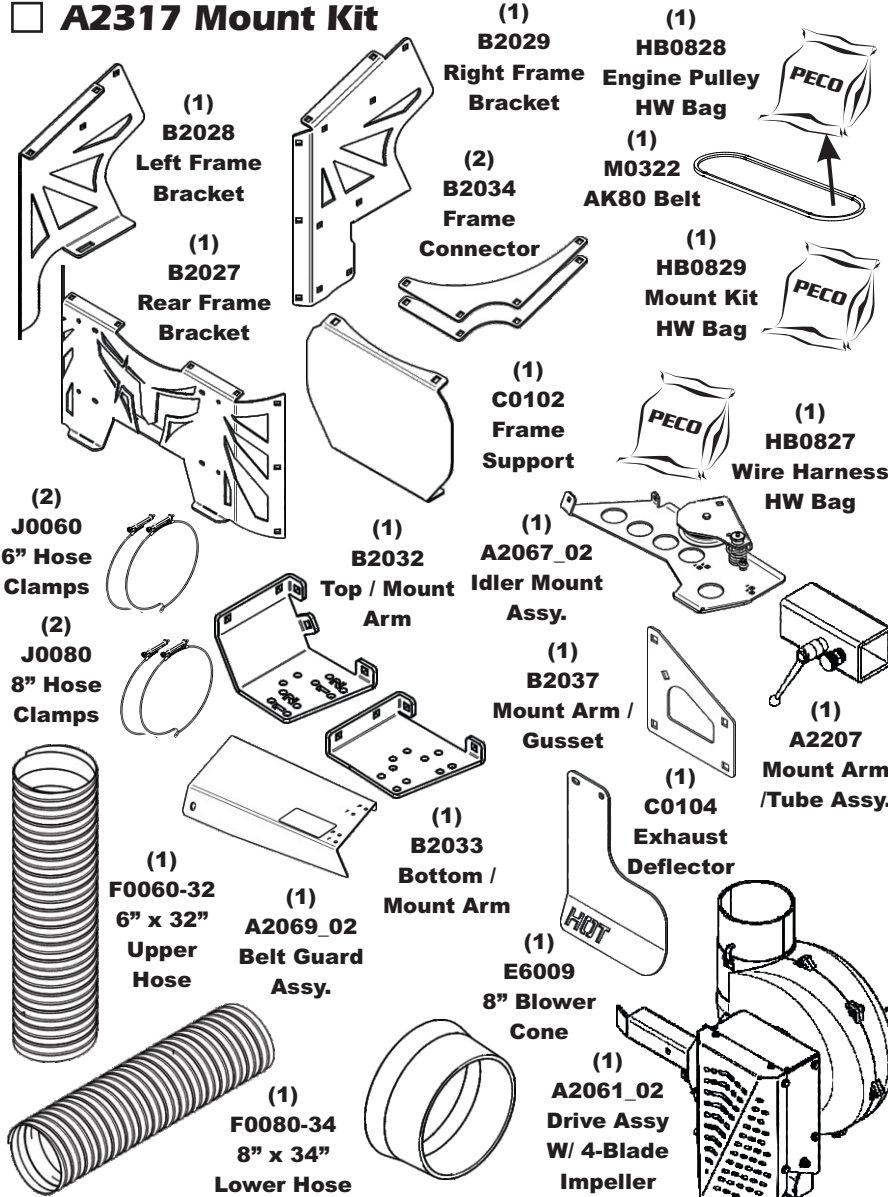

A2315 Boot Kit

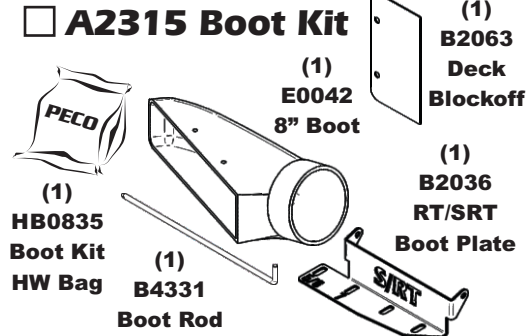

A2162 Quad Weight Kit / Single Caster

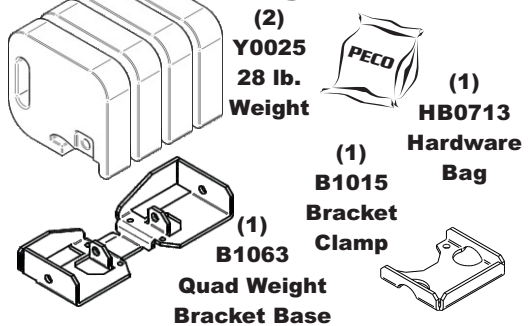

A2121 Dual Weight Kit / Single Caster

